

**OUTILS DÉDIÉS À L'USINAGE DU PLASTIQUE,
COMPOSITES, ALUMINIUM**

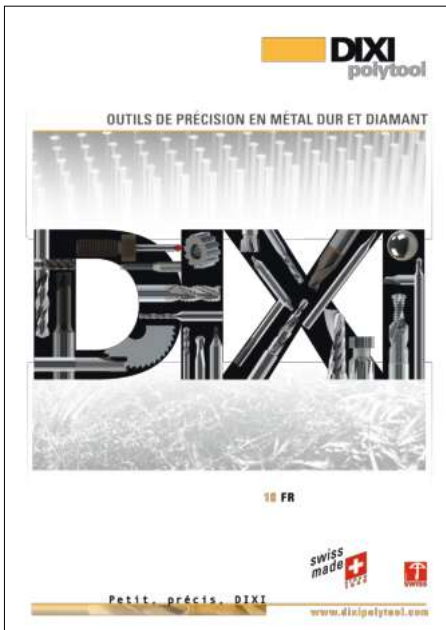

Petit, précis, DIXI

Outils de précision en métal dur



Alésoirs de précision

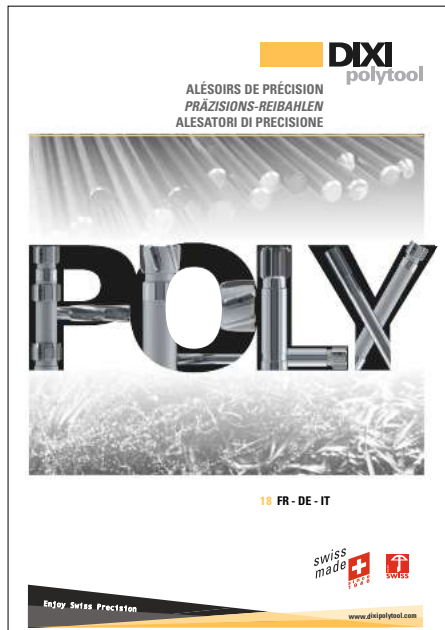

Jauges de précision

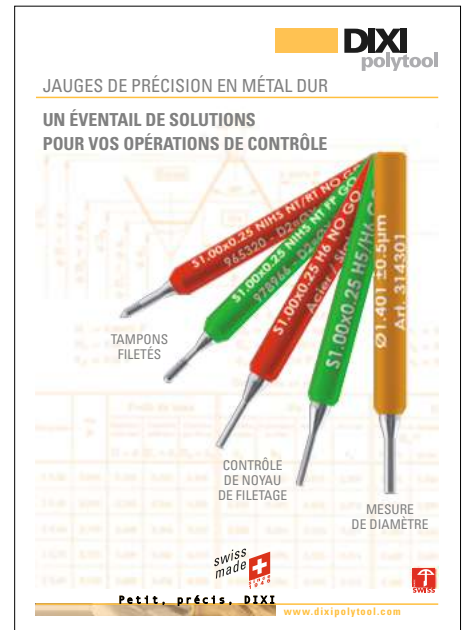

Outils diamant et PCD



DIXI POLYTOOL est partenaire de l'athlète suisse KARIEM HUSSEIN



FRAISES 1 DENT



2-5

FRAISES À GRAVER

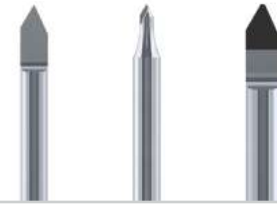

6-9

FRAISES EN BOUT HÉLICOÏDALES



10-12

FRAISES HÉMISPHERIQUES



13-14

FRAISES ÉBAUCHE



14-15

FRAISES À ANGLER, PLIER ET RAINURER



15-20

FRAISES PCD



21-23

FRAISES À SURFACER



23-24

PINCES ER



25

DIXI 7305

FRAISES 1 DENT POUR PLASTIQUE
HÉLICE À DROITE

Z = 1

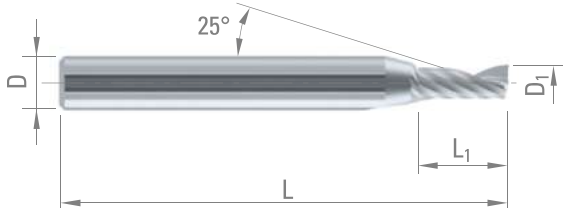

D _{1 e8}	D _{h5}	L ₁	L	CARBURE
1.00	3.0	4.0	30	372568
		4.0	38	372569
1.50	3.0	6.0	30	372570
		6.0	38	372571
1.50	3.0	8.0	60	372572
2.00	2.0	8.0	30	372573
		8.0	30	372574
2.00	3.0	8.0	38	372575
		8.0	60	372576
		8.0	60	372577
2.00	6.0	8.0	50	372578
2.50	2.5	8.0	38	372579
2.50	3.0	8.0	30	372580
		8.0	38	372581
		8.0	60	372582
		8.0	60	372583
		8.0	60	372584
3.00	3.0	10.0	30	372584
		10.0	38	372585
		15.0	50	372586
3.00	4.0	8.0	60	372587
		10.0	40	372588
		15.0	50	372589
3.00	6.0	10.0	50	372590
		10.0	60	372591
		12.0	60	372592
		20.0	60	372593
3.50	3.5	12.0	50	372594
3.50	4.0	10.0	60	372595
		12.0	50	372596
3.50	5.0	12.0	50	376933
4.00	4.0	8.0	50	376934
		12.0	50	372597
		12.0	60	372598
		16.0	60	372599
		22.0	60	372600
		25.0	60	376935
		30.0	70	372601
4.00	6.0	12.0	50	372602
		12.0	60	372603
		12.0	80	372604
		12.0	101	376936
		21.0	60	372605
5.00	5.0	16.0	50	372606
		16.0	60	372607
		30.0	70	372608

D _{1 e8}	D _{h5}	L ₁	L	CARBURE
5.00	6.0	12.0	60	376937
		16.0	60	372609
		20.0	60	372610
5.00	8.0	25.0	60	372611
		25.0	80	372612
6.00	6.0	12.0	60	376938
		20.0	50	372613
		20.0	60	372614
		24.0	70	372615
		30.0	70	372616
		38.0	80	372617
		20.0	80	372618
6.00	8.0	25.0	80	372619
		30.0	80	372620
		32.0	80	372621
		38.0	80	372622
		23.0	60	372623
		25.0	80	372624
8.00	8.0	32.0	80	372625
		33.0	80	372626
		38.0	80	372627
		24.0	75	372628
10.00	10.0	30.0	75	372629
		30.0	80	372630
12.00	12.0	51.0	100	372631



DIXI 7306

FRAISES 1 DENT POUR PLASTIQUE
HÉLICE À GAUCHE, COUPE À DROITE

Z = 1

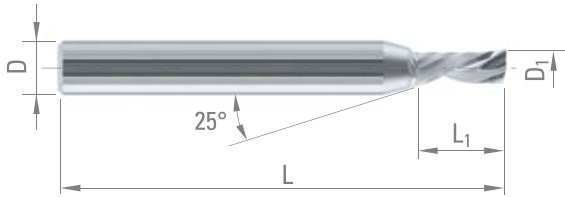

D _{1 e8}	D _{h5}	L ₁	L	CARBURE
1.00	3.0	4.0	30	379705
		4.0	38	372632
1.50	3.0	6.0	30	379706
		6.0	38	372633
1.50	3.0	8.0	60	372634
2.00	2.0	8.0	30	372635
		8.0	30	379707
2.00	3.0	8.0	38	372636
		8.0	60	372637
2.00	4.0	8.0	60	379708
2.00	6.0	8.0	50	379709
		8.0	60	379710
2.50	2.5	8.0	38	379710
		8.0	30	379711
2.50	3.0	8.0	38	372639
		8.0	60	372640
		8.0	60	372641
		8.0	60	372642
3.00	3.0	10.0	30	379712
		10.0	38	372642
		15.0	50	372643
3.00	4.0	8.0	60	372644
		10.0	40	372645
		15.0	50	372646
3.00	6.0	10.0	50	372647
		10.0	60	372648
		12.0	60	372649
		20.0	60	372650
3.50	3.5	12.0	50	372651
3.50	4.0	10.0	60	372652
		12.0	50	379713
3.50	5.0	12.0	50	379717
4.00	4.0	8.0	50	379718
		12.0	50	372653
		12.0	60	372654
		16.0	60	372655
		22.0	60	372656
		25.0	60	379720
		30.0	70	372657
4.00	6.0	12.0	50	372658
		12.0	60	372659
		12.0	80	372660
		12.0	101	379721
5.00	5.0	21.0	60	379723
		16.0	50	379724
		16.0	60	372661
		30.0	70	372662

D _{1 e8}	D _{h5}	L ₁	L	CARBURE
5.00	6.0	12.0	60	379726
		16.0	60	372663
		20.0	60	372664
5.00	8.0	25.0	60	379727
		25.0	80	372665
6.00	6.0	12.0	60	379728
		20.0	50	372666
		20.0	60	372667
		24.0	70	372668
		30.0	70	372669
		38.0	80	372670
6.00	8.0	20.0	80	372671
		25.0	80	372672
		30.0	80	372673
		32.0	80	379729
		38.0	80	379730
		23.0	60	372674
8.00	8.0	25.0	80	372675
		32.0	80	379731
		33.0	80	372676
		38.0	80	372677
10.00	10.0	24.0	75	372678
		30.0	75	372679
12.00	12.0	30.0	80	372680
		51.0	100	379732



DIXI 7307

FRAISES 1 DENT POUR ALUMINIUM
ET COMPOSITES (TYPE DIBOND)

Z = 1

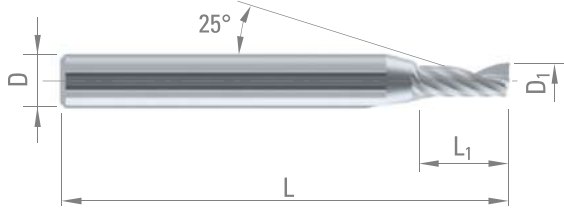

D _{1 e8}	D _{h5}	L ₁	L	CARBURE	DLC
1.00	3.0	3.0	30	372681	372719
		3.0	38	372682	372720
1.50	3.0	4.0	30	372683	372721
		4.0	38	372684	372722
2.00	3.0	5.0	30	372685	372723
		5.0	38	372686	372724
2.00	6.0	5.0	38	372687	372725
2.50	3.0	6.0	30	372688	372726
		6.0	38	372689	372727
3.00	3.0	5.0	38	372690	372728
		8.0	30	372691	372729
		8.0	38	372692	372730
3.00	4.0	8.0	40	372693	372731
3.00	6.0	10.0	50	372694	372732
		5.0	40	372695	372733
		10.0	50	372696	372734
4.00	4.0	20.0	60	372697	372735
		30.0	70	372698	372736
		5.0	50	381024	381025
4.00	6.0	10.0	50	372699	372737
		20.0	60	372700	372738
5.00	5.0	15.0	60	372701	372739
		30.0	70	372702	372740
5.00	6.0	12.0	50	372703	372741
5.00	8.0	25.0	80	372704	372742
		12.0	50	372705	372743
		15.0	70	372706	372744
		21.0	60	372707	372745
		30.0	70	372708	372746
6.00	6.0	38.0	80	372709	372747
		12.0	60	372710	372748
		22.0	80	372711	372749
		30.0	80	372712	372750
8.00	8.0	24.0	60	372713	372751
		38.0	80	372714	372752
		24.0	60	372715	372753
10.00	10.00	30.0	75	372716	372754
		40.0	100	372717	372755
12.00	12.00	30.0	80	372718	372756
		38.0	100	376944	376945



DIXI 7308-xD

FRAISES TORIQUES 1 DENT DÉGAGÉES
POUR PROFILÉ ALUMINIUM

Z = 1

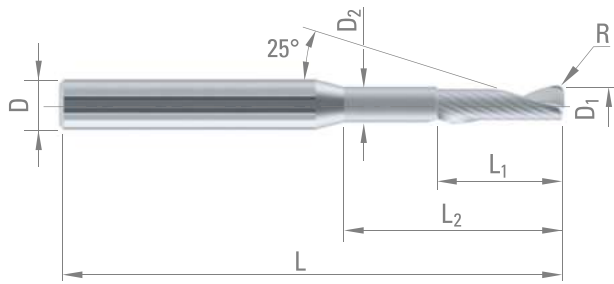

Ebauche



Finition



D _{1 e8}	L ₁	D ₂	L ₂	D _{h5}	L	R	CARBURE
6.00	20.0	5.6	35	8.0	80	1.5	372757
8.00	22.0	7.6	50	10.0	90	1.5	372758

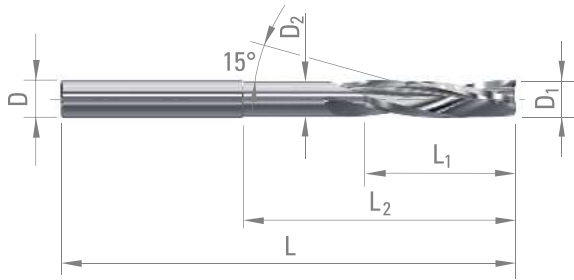
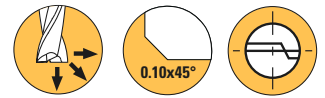

Mousse

Ebauche
●●●●○

Finition
●●●●○

D ₁	L ₁	D ₂	L ₂	D	L	CARBURE
3.00	12.0	2.4	20	3	50	389845
3.00	20.0	2.4	45	3	75	389846
4.00	30.0	3.6	45	4	75	389847
6.00	25.0	5.6	45	6	75	389848
6.00	40.0	5.6	70	6	100	389849
8.00	25.0	7.6	45	8	75	389850
8.00	40.0	7.6	70	8	100	389851
10.00	40.0	9.6	70	10	100	389852
10.00	50.0	9.6	85	10	120	389853
12.00	50.0	11.6	115	12	150	389854

DIXI 7020

FRAISES À GRAVER 180°
EXÉCUTION SEMI-FINIE

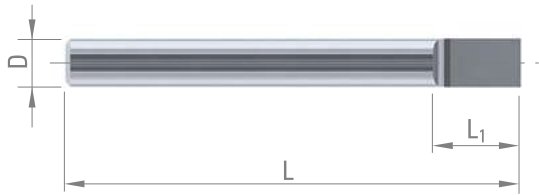

D_{h5}	L_1	L	CARBURE
2	3	25	35671
3	4	38	35672
4	5	50	35673
5	6	50	35674
6	8	57	35675
8	10	63	35676
10	12	72	35677

DIXI 7017

FRAISES À GRAVER 1/2
EXÉCUTION TERMINÉE

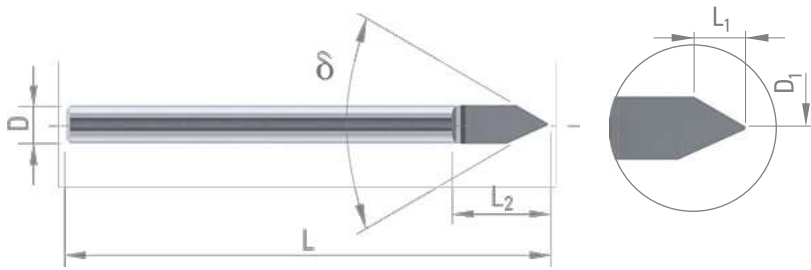

Acier + Pb	Acier faibl. allié	Acier fort. allié	Acier inox aust.	Fontes
Super alliages Ni / Co	Titane, alliage de titane	Alliage Cu Argent Or	Alliage Cu difficile	Alu
Graphite	Plastique			

δ	L_1	L_2	D_{h6}	L	$D_{1 \pm 0.01}$	CARBURE	DINAC	DLC*
30°	4.0	5.2	3	38	0.05	961336	962814	961337
					0.10	961338	962813	961339
					0.15	961340	962812	961342
					0.20	961341	962116	961343
30°	10.2	12	6	57	0.20	376946		
					0.30	376947		
					0.50	376949		
40°	7.9	12	6	57	0.20	376950		
50°	3.0	6	3	38	0.05	961326	961327	
					0.08	961328	961333	
					0.10	961329	961332	
					0.15	961330	961334	
					0.20	961331	961335	
60°	2.4	6	3	38	0.05	43536	959712	
					0.08	972400	972401	
					0.10	40939	959713	
					0.15	953721	960610	
60°	3.3	8	3	38	0.20	954292	960611	
					0.05	43537	959714	
					0.10	45813	959716	
90°	1.45	8	3	38	0.20	45814	959717	
					0.05	961246	961248	
90°	1.45	8	3	38	0.10	961247	961249	
					0.05	961322	961323	
120°	0.84	8	3	38	0.10	961324	961325	

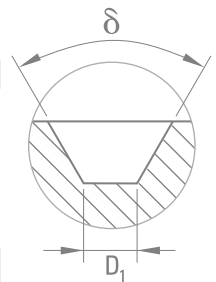

* pour matériaux non-ferreux



Exemples de commande

DIXI 7017 / 50° $D_1 = 0.10$ DINAC ou Art. 961332 DIXI 7017 / 30° $D_1 = 0.05$ DLC ou Art. 961337



DIXI 7007

FRAISES À GRAVER 3/4
EXÉCUTION TERMINÉE

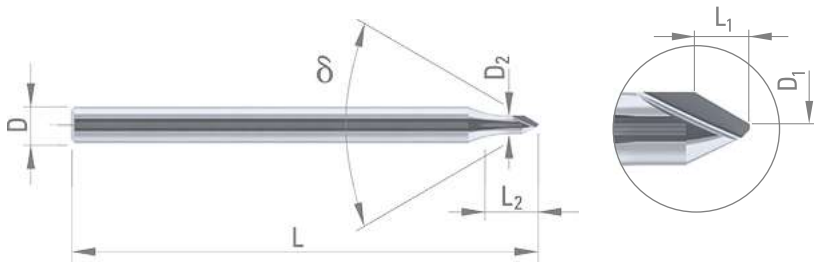

Acier + Pb	Acier faibl. allié	Acier fort. allié	Acier inox aust.	Aciers Fontes 45-55 HRC
Fontes	Super alliages Ni / Co	Titane, alliage de titane	Alliage Cu Argent Or	Alliage Cu difficile
Alu	Graphite	Plastique		

δ	L_1	L_2	D_2	D_{h6}	L	$D_{1\pm 0.01}$	CARBURE	DINAC
30°	2.5	3.4	1.5	3	38	0.05	976370	976374
						0.08	976371	976375
						0.10	976372	976376
						0.15	976373	976377
35°	2.0	3.4	1.5	3	38	0.05	65846	959722
						0.08	961244	961245
						0.10	65848	959724
						0.15	65850	959725
40°	1.7	3.2	1.5	3	38	0.05	961225	961238
						0.08	961242	961243
						0.10	961226	961239
						0.15	961227	961240
50°	1.4	2.3	1.5	3	38	0.05	976258	976264
						0.08	976260	976265
						0.10	976261	976266
						0.15	976263	976267
60°	1.1	2.3	1.5	3	38	0.05	976361	976365
						0.08	976362	976366
						0.10	976363	976367
						0.15	976364	976368

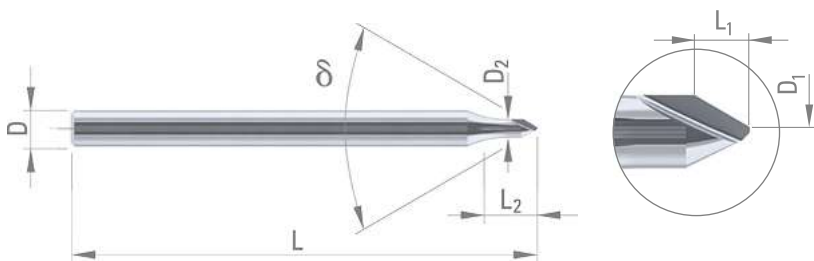
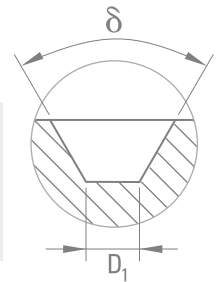

δ	L_1	L_2	D_2	D_{h6}	L	$R_{\pm 0.01}$	CARBURE	DINAC
35°	1.9	3.4	1.5	3	38	0.05	51736	959718
						0.10	51625	959719
						0.15	51734	959720
						0.20	51735	959721

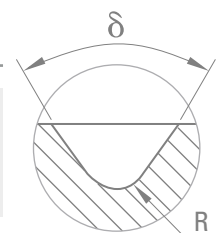

Exemples de commande

DIXI 7007 / 30° $D_1 = 0.08$ DINAC ou Art. 976375

DIXI 7007 / 35° $R = 0.15$ CARBURE ou Art. 51734



DIXI 70170 DIA

FRAISES À GRAVER
DIAMANT MONOCRISTALLIN

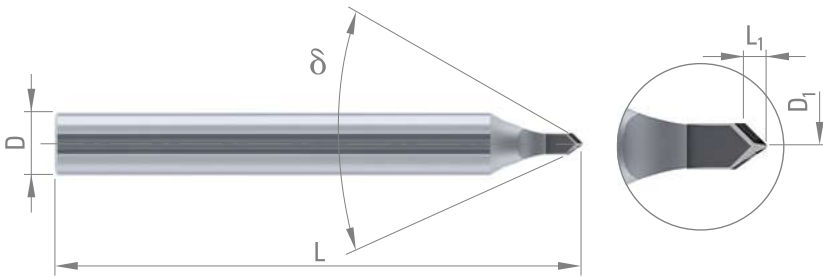

- Alliage Cu
Argent
Or
- Alliage
Cu
difficile
- Alu
- Plastique

δ	L_1	D_{h5}	L	D_1	DIA
60°	1.40	6	50	0.05	302597
				0.10	302598
90°	0.80	6	50	0.05	302599
				0.10	302600

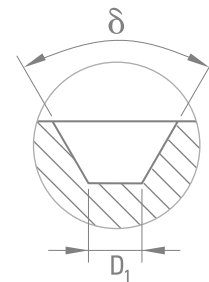

DIXI 70170 PCD

FRAISES À GRAVER PCD

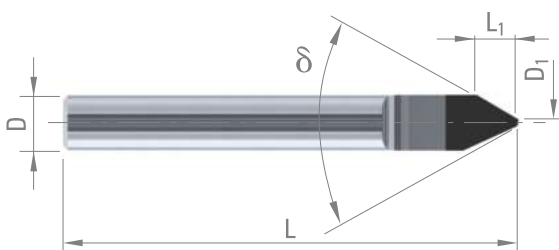

- Alliage Cu
Argent
Or
- Alliage
Cu
difficile
- Alu
- Graphite
- Carbure
Céramique
verte
- Plastique
- Fibre de
carbone

δ	L_1	D_{h5}	L	D_1	PCD
60°	5	6	50	0.10	303081
				0.20	303082
90°	3	6	50	0.10	303083
				0.20	303084

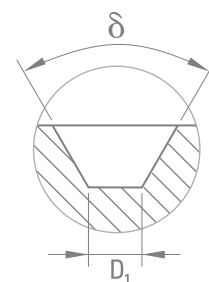

DIXI 7582

FRAISES EN BOUT HÉLICOÏDALES
CORPS RENFORCÉ

Z = 2

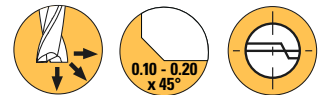

$D_1 \geq 2.8$

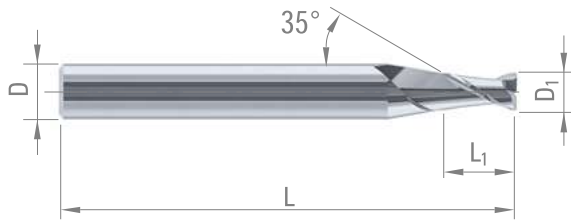

Acier + Pb	Fontes	Titane, alliage de titane	Alliage Cu Argent Or	Alliage Cu difficile
Alu	Plastique			

Ebauche
●●●●○

Finition
●●●●○

D_1	L_1	D_{h5}	L	CARBURE	TiAIN
$\emptyset < 2.00 - 0/-0.01$					
$\emptyset < 3.00 - 0/-0.02$					
$\emptyset \geq 3.00 - e8$					
1.00	2.0	3	38	47357	56304
1.50	3.0	3	38	47358	56305
2.00	4.0	4	50	47359	56306
2.50	5.0	4	50	47360	56307
2.80	6.0	6	50	35734	36304
3.00	6.0	6	50	30298	36305
3.80	8.0	6	50	34973	36306
4.00	8.0	6	50	30299	36607
4.50	10.0	6	50	35709	56983
5.00	10.0	6	50	30300	36309
5.50	10.0	6	50	35735	56303
6.00	10.0	6	50	29100	36299
8.00	15.0	8	60	29101	36300
10.00	18.0	10	66	29102	56334
12.00	20.0	12	73	30521	36302
16.00	25.0	16	82	30523	56318
20.00	35.0	20	104	31858	56335



DIXI 7572

FRAISES EN BOUT HÉLICOÏDALES
LONGUES

Z = 2

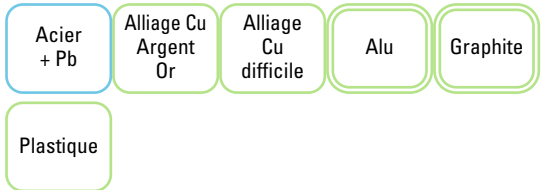
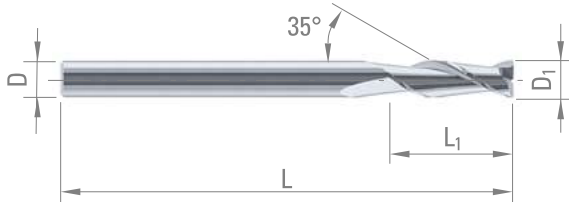
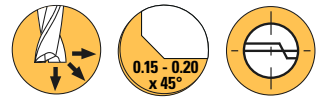

D ₁ e8	L ₁	D _{h5}	L	CARBURE	TiAIN	DIAMANT*
3.00	14.0	3	50	32484	56320	57045
4.00	16.0	4	50	32485	56321	57046
5.00	18.0	5	60	32486	56322	57047
6.00	20.0	6	75	32487	56337	57048
7.00	22.0	7	75	32488		
8.00	25.0	8	75	32489	56336	57050
10.00	30.0	10	90	32491	56341	
12.00	36.0	12	100	32492	56342	

* pour matériaux non-ferreux

DIXI 7254 CUTINOX

FRAISES À HÉLICES DIFFÉRENTES
DÉGAGÉES

Z = 4

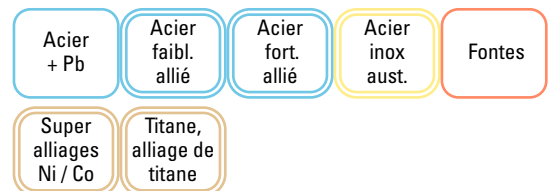
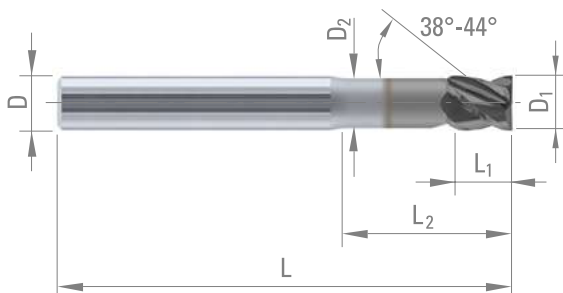
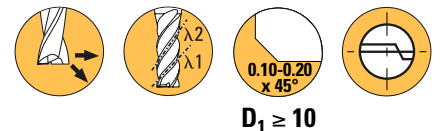

D ₁ e8	L ₁	D ₂	L ₂	D _{h5}	L	CUTINOX
3.00	4.0	2.80	9	6	57	968686
4.00	5.0	3.70	12	6	57	968687
5.00	6.0	4.60	15	6	57	968688
6.00	7.0	5.50	18	8	63	968689
8.00	9.0	7.50	24	10	72	968690
10.00	11.0	9.30	30	10	72	968691
12.00	13.0	11.20	36	12	83	968692
16.00	17.0	15.20	48	16	92	968693

DIXI 7264 - 7264-3D CUTINOX

FRAISES À HÉLICES DIFFÉRENTES
ET PAS DÉCALÉ

Z = 4



$D_1 \geq 10$

7264

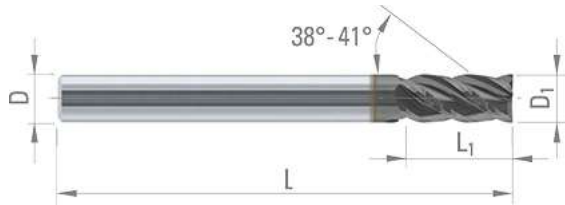

7264-3D



Ebauche



Finition



D_1
 $\emptyset < 3.00 - 0/-0.02$
 $\emptyset \geq 3.00 - e8$

D_1	L_1	D_{h5}	L	DIXI	D_2	L_2	CUTINOX
1.50	3.0	3	38	7264	-	-	974805
2.00	4.0	3	38	7264	-	-	974804
3.00	8.0	6	57	7264	-	-	968672
4.00	11.0	6	57	7264	-	-	968678
5.00	13.0	6	57	7264	-	-	968679
6.00	13.0	6	57	7264	-	-	968680
				7264-3D	5.50	18	997930
8.00	19.0	8	63	7264	-	-	968681
				7264-3D	7.50	24	997931
10.00	22.0	10	72	7264	-	-	968682
				7264-3D	9.25	30	997932
12.00	26.0	12	83	7264	-	-	968683
				7264-3D	11.00	36	997933
16.00	32.0	16	92	7264	-	-	968684
				7264-3D	15.00	48	997934
20.00	38.0	20	104	7264	-	-	968685
				7264-3D	19.00	60	997935



DIXI 7032

FRAISES HÉMISPHERIQUES

Z = 2

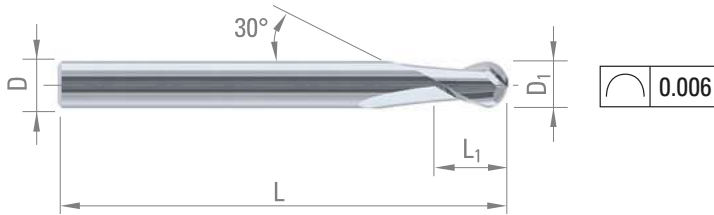
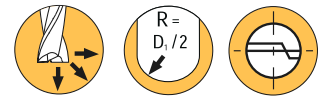

Acier + Pb	Acier faibl. allié	Acier fort. allié	Acier inox aust.	Fontes
Super alliages Ni / Co	Titane, alliage de titane	Alliage Cu Argent Or	Alliage Cu difficile	Alu
Graphite	Plastique			

D ₁	L ₁	D _{h5}	L	CARBURE TiAIN	DICUT	DIAMANT*	Ebauche	Finition
Ø < 0.30 - 0/-0.01							●●●●●	●●●●●
Ø < 3.00 - 0/-0.02								
Ø ≥ 3.00 - e8								

0.06	0.12	3	38	959060			
0.08	0.16	3	38	959059			
0.10	0.20	3	38	959058			
0.15	0.30	3	38	954665			
0.20	0.30	3	38	952795	952796	952797	952799
0.25	0.40	3	38	952800	952801	952802	952803
0.30	0.50	3	38	952804	952805	952806	58852
0.40	0.60	3	38	952807	952808	952809	952810
0.50	0.80	3	38	952811	952812	952813	952814
0.60	0.90	3	38	952815	952816	952817	952818
0.70	1.10	3	38	952819	952820	952821	950363
0.80	1.20	3	38	952822	952823	950703	950364
0.90	1.40	3	38	952825	952826	952824	950365
1.00	1.50	3	38	952827	952828	952829	952830
1.10	1.70	3	38	952832	952833	952831	950366
1.20	1.80	3	38	952835	952836	952834	950367
1.30	1.90	3	38	952838	952839	952837	950368
1.40	2.10	3	38	952841	952842	952840	950369
1.50	2.30	3	38	952843	952846	952845	952844
1.60	2.50	3	38	55539	955784	956236	956237
1.70	2.50	3	38	60112	956238	956239	956240
1.80	2.75	3	38	48747	956241	956242	956243
1.90	2.75	3	38	57714	956244	956245	956246
2.00	3.00	3	38	44604	56136	64280	59783
2.10	3.00	3	38	55540	956247	956248	956249
2.20	3.50	3	38	48457	956250	956251	956253
2.30	3.50	3	38	66547	62925	956254	956255
2.40	3.50	3	38	60788	62926	956256	956257
2.50	4.00	3	38	44605	56137	64288	60221
3.00	5.00	3	38	43115	56138	63876	59988
3.50	6.00	4	50	44607	56139	64289	950370
4.00	6.00	4	50	34120	56140	64290	59784
4.50	7.00	5	50	44609	56141	64291	950371
5.00	8.00	5	50	34748	36172	64292	60222
5.50	9.00	6	57	44611	56172	64293	950372
6.00	9.00	6	57	34749	56179	63923	46800
7.00	11.00	7	60	34740	56176	64294	66878
8.00	12.00	8	63	43389	36174	64295	58860
10.00	15.00	10	72	42940	56177	63924	36175
12.00	18.00	12	73	32387	56173	64296	60223
16.00	24.00	16	82	32136	56175		
20.00	30.00	20	104		56183		

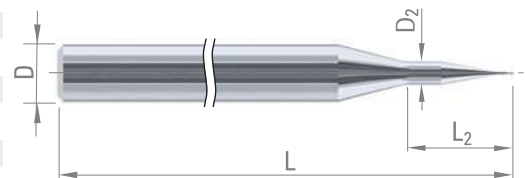

Pour $D_1 \leq 0.15$:
 $D_2 = 1.20$
 $L_2 = 5.30$

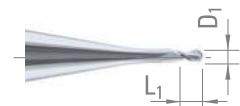

* pour matériaux non-ferreux



DIXI 7042

FRAISES HÉMISPHERIQUES

Z = 2

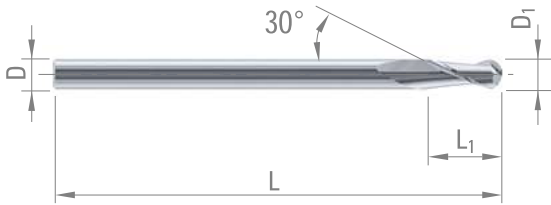
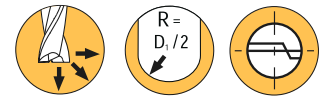

0.006

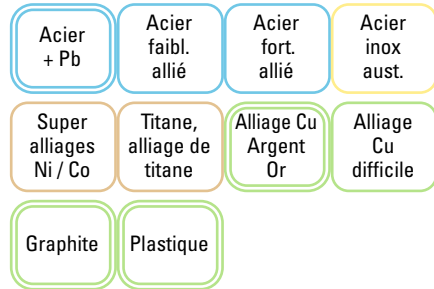

Ebauche



Finition



D _{1 e8}	L ₁	D _{h5}	L	CARBURE	TiAIN	DIAMANT*
2.00	10	2	61	41974	56238	60224
3.00	10	3	61	39512	56239	60225
4.00	12	4	75	38639	56240	60226
5.00	14	5	86	38942	56241	60227
6.00	16	6	93	38623	56242	60228
8.00	20	8	100	38640	56243	60229
10.00	24	10	100	38641	56244	58790
12.00	28	12	110	40728	56245	60230
16.00	36	16	120	40730	56247	
20.00	45	20	150	40732	56248	

* pour matériaux non-ferreux

DIXI 7215

FRAISES ÉBAUCHE ALU

Z = 3

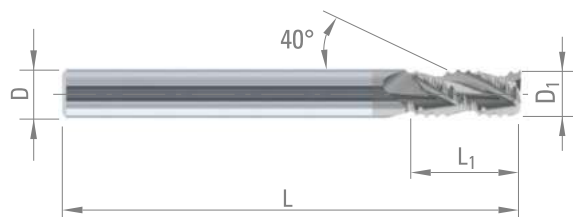

Ebauche



Finition

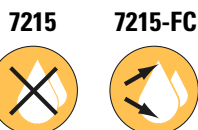

D _{1 d12}	L ₁	D _{h6}	L	7215 DAC	7215-FC DAC
6.00	13.0	6	57	993017	995594
8.00	19.0	8	63	993018	995595
10.00	22.0	10	72	993003	995596
12.00	26.0	12	83	990143	995597
16.00	32.0	16	92	993019	307320



Sur demande



DIXI 7217

FRAISES ÉBAUCHE PLASTIQUE

Z = 4

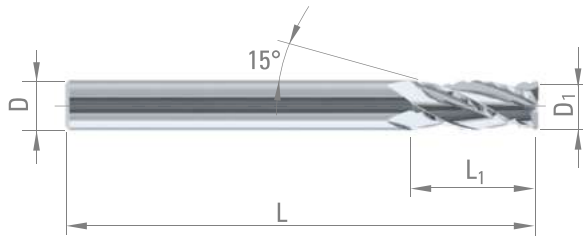

Plastique

Ebauche



Finition



$D_{1\ d12}$	D_{h5}	L_1	L	CARBURE
6.00	6	16	50	381093
		25	75	381095
8.00	8	22	63	381096
		33	79	381097
10.00	10	32	73	381098
		42	102	381100
12.00	12	42	102	381101



Sur demande

DIXI 7626

FRAISE À ANGLER
PLAQUETTE BRASÉE

Z = 2

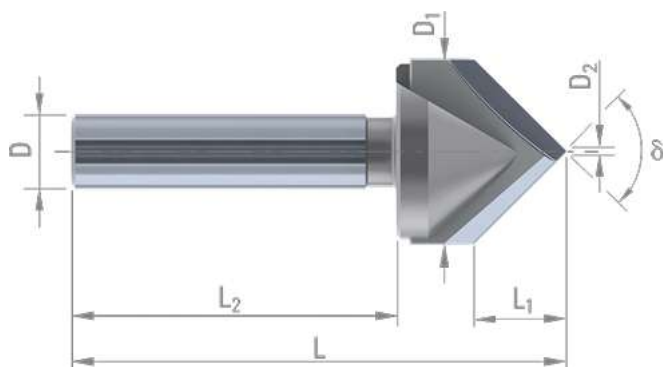
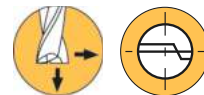

Plastique

δ	$D_{1\ h6}$	L_1	L_2	D_{h6}	$D_{2\pm 0.05}^*$	L	CARBURE neuf	CARBURE réaffûté
60°	20	17	35	8	0.3	60	381111	381120
90°	20	9.8	35	8	0.3	53	381112	381121
100°	20	8.2	35	8	0.3	51	381113	381122
110°	20	6.8	35	8	0.3	50	381114	381123
120°	20	5.6	35	8	0.3	49	381115	381124
130°	20	4.5	35	8	0.3	48	381116	381125
140°	20	3.5	35	8	0.3	47	381117	381126
150°	20	2.6	35	8	0.3	46	381118	381127
160°	20	1.7	35	8	0.3	45	381119	381128

*non coupant



DIXI 7627

FRAISE À PLIER ET RAINURER
CARBURE MONOBLOC

Z = 2

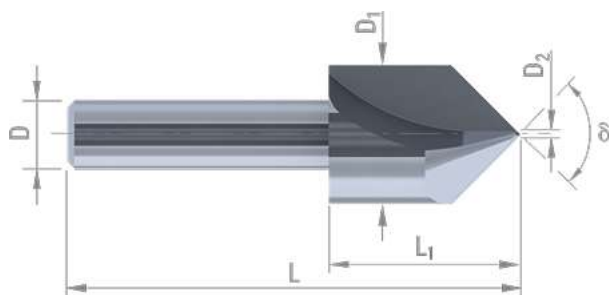
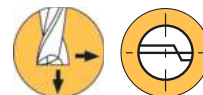

Plastique

δ	$D_{1\ h5}$	L_1	D_{h5}	$D_{2\pm 0.05}$	L	CARBURE neuf	CARBURE réaffûté
45°	16	22	8	0.2	50	381129	381137
90°	8	22	8	0.2	50	381130	381138
90°	12	22	12	0.2	50	381131	381139
90°	16	22	8	0.2	50	381132	381140
90°	16	22	16	0.2	50	381133	381141
90°	22	22	20	0.2	50	381134	381142
90°	24	22	20	0.2	60	381135	381143
92°	12	22	12	0.2	50	381136	381144



DIXI 7628

FRAISE À PLIER ET RAINURER
PLAQUETTE BRASÉE

Z = 2

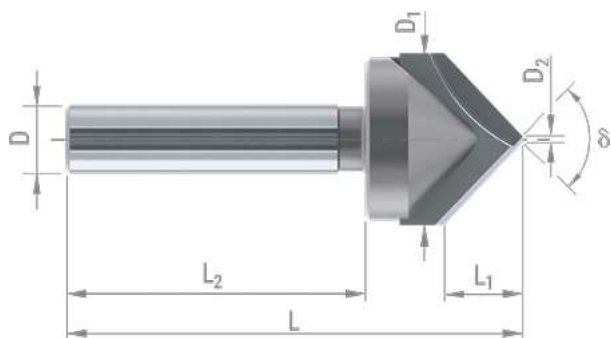
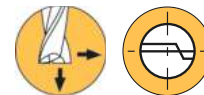

Dibond

CARBURE CARBURE

δ	$D_{1\ h6}$	L_1	L_2	D_{h5}	$D_{2 \pm 0.05}$	L	CARBURE neuf	CARBURE réaffûté
92°	20	9.5	35	8	3	53	380752	380759
135°	20	4.0	35	8	2	47	380758	380760



DIXI 7629

FRAISES À ANGLER, PLIER ET RAINURER

Z = 3

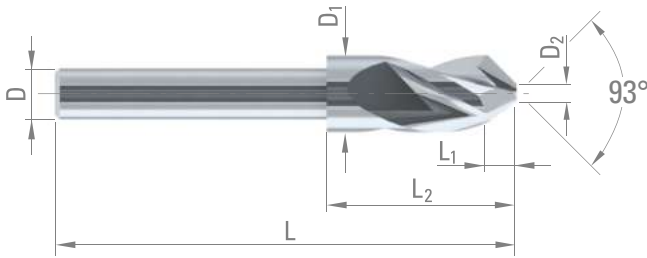
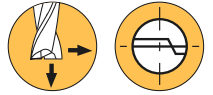

Dibond

$D_{1\ h5}$	L_1	L_2	$D_{2\pm 0.05}$	D_{h5}	L	CARBURE
10	4.1	30	1.2	6	72	381677
10	3.3	30	3.0	6	72	381678
10	4.1	-	1.2	10	72	381679
10	3.3	-	3.0	10	72	381680
12	5.1	32	1.2	8	73	381681
12	4.2	32	3.0	8	73	381682
12	5.1	-	1.2	12	73	381683
12	4.2	-	3.0	12	73	381684



DIXI 7632

FRAISES MULTIFONCTIONS

Z = 2

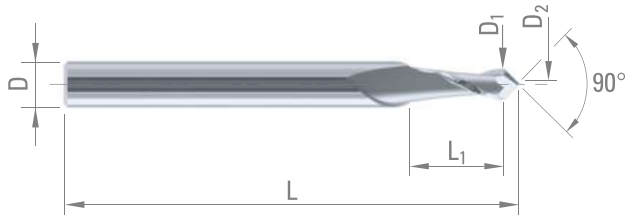
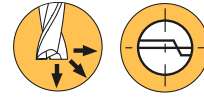

Acier + Pb	Acier faibl. allié	Acier fort. allié	Acier inox aust.	Fontes
Titane, alliage de titane	Alliage Cu Argent Or	Alliage Cu difficile	Alu	Plastique

D _{1 e8}	L ₁	D ₂	D _{h5}	L	CARBURE CUTINOX	
0.10	0.2	0.01	3	38	333883	333907
0.20	0.4	0.02	3	38	333884	333908
0.30	0.6	0.03	3	38	333885	333909
0.40	0.8	0.04	3	38	333886	333910
0.50	1.0	0.05	3	38	333887	333911
0.60	1.2	0.06	3	38	333888	333912
0.70	1.4	0.07	3	38	333889	333913
0.80	1.6	0.08	3	38	333890	333914
0.90	1.8	0.09	3	38	333891	333915
1.00	2.0	0.10	3	38	333892	333916
1.10	2.2	0.11	3	38	333893	333917
1.20	2.4	0.12	3	38	333894	333918
1.30	2.6	0.13	3	38	333895	333919
1.40	2.8	0.14	3	38	333896	333920
1.50	3.0	0.15	3	38	333897	333921
2.00	4.0	0.20	3	38	333898	333922
2.50	5.0	0.25	3	38	333899	333923
3.00	6.0	0.30	4	50	333900	333924
4.00	8.0	0.40	5	50	333901	333925
5.00	10.0	0.50	6	50	333902	333926
6.00	12.0	0.60	8	60	333903	333927
8.00	16.0	0.80	10	70	333904	333928
10.00	18.0	1.00	12	70	333905	333929
12.00	20.0	1.20	12	70	333906	333930

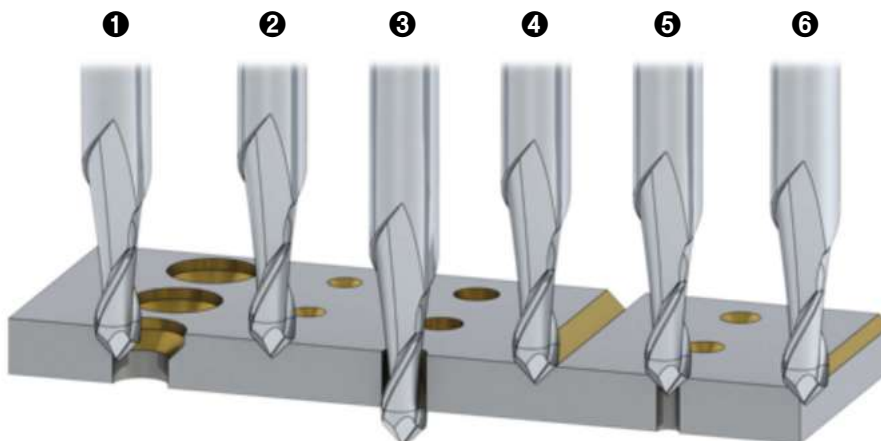

- ❶ Noyure
- ❷ Pointage
- ❸ Perçage
- ❹ Rainurage
- ❺ ❻ Chanfreinage



DIXI 7656

FRAISES À RAYONNER

Z = 2

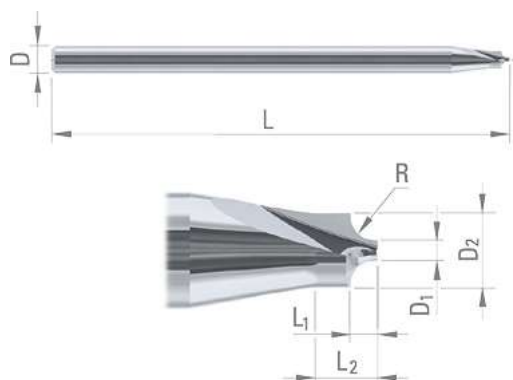
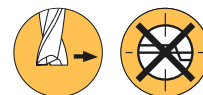

Acier + Pb	Acier faibl. allié	Acier fort. allié	Acier inox aust.	Fontes
Super alliages Ni / Co	Titane, alliage de titane	Alliage Cu Argent Or	Alliage Cu difficile	Alu
Plastique				

$R_{\pm 0.02}$	D_1	L_1	D_2	L_2	D_{h5}	L	CARBURE	TAIN
0.10	0.50	0.12	0.74	0.8	3	38	969577	969578
0.15	0.50	0.18	0.86	0.8	3	38	969586	969597
0.20	0.50	0.24	0.98	0.8	3	38	969587	969598
0.25	0.50	0.30	1.10	1.0	3	38	969588	969599
0.30	0.50	0.36	1.22	1.0	3	38	969589	969600
0.40	0.50	0.48	1.46	1.0	3	38	969590	969601
0.50	0.50	0.60	1.70	1.5	3	38	969591	969602
0.60	0.50	0.70	1.90	1.5	3	38	969592	969603
0.70	0.50	0.80	2.10	1.5	3	38	969593	969604
0.80	0.80	0.90	2.60	2.0	3	38	969594	969605
0.90	0.80	1.00	2.80	2.0	3	38	969595	969606
1.00	0.80	1.10	-	-	3	38	969596	969607

DIXI 7658

FRAISES À RAYONNER CARBURE MONOBLOC

Z = 4

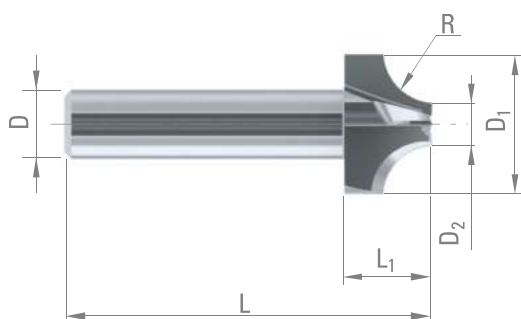
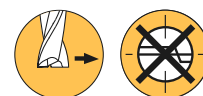

Acier + Pb	Acier faibl. allié	Acier fort. allié	Acier inox aust.	Fontes
Super alliages Ni / Co	Titane, alliage de titane	Alliage Cu Argent Or	Alliage Cu difficile	Alu
Plastique				

$R_{\pm 0.02}$	$D_{1 h5}$	L_1	D_2	D_{h5}	L	CARBURE
1.0	10.0	10.0	8.0	6	42	381167
2.0	10.0	10.0	6.0	6	42	381168
3.0	12.0	10.0	6.0	8	42	381169
4.0	12.0	10.0	4.0	8	42	381170
5.0	16.0	10.0	6.0	8	42	381171
6.0	16.0	10.0	4.0	8	42	381172
6.0	20.0	10.0	4.0	8	42	381173

DIXI 1550 R + L

FRAISES À T
PLAQUETTES BRASÉES

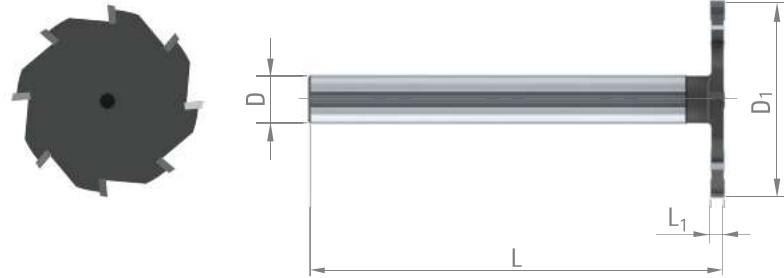

Plastique

DIXI 1550 R

D_{1js12}	L_1	D_{h6}	L	Z	CARBURE
15	1.5	6	80	6	381174
25	1.5	6	80	6	381175
25	2.0	6	80	6	381176
25	2.0	8	80	6	381177
35	2.0	8	80	6	381178
50	3.0	10	80	8	381179

DIXI 1550 L

D_{1js12}	L_1	D_{h6}	L	Z	CARBURE
15	1.5	6	80	6	381180
25	1.5	6	80	6	381181
25	2.0	6	80	6	381182
25	2.0	8	80	6	381183
35	2.0	8	80	6	381184
50	3.0	10	80	8	381185

DIXI 72420-SH PCD

FRAISES EN BOUT
AVEC COUPE AU CENTRE
ET TROUS DE LUBRIFICATION

Z = 1-2

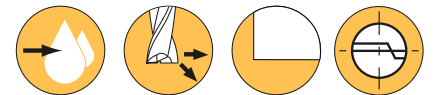

$D_1 \geq \varnothing 6$

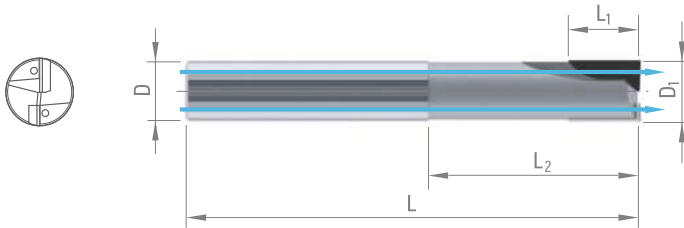

- Alliage Cu Argent Or
- Alliage Cu difficile
- Alu 4-8% Si
- Alu 8-13% Si
- Graphite
- Carbure Céramique verte
- Plastique
- Fibre de carbone

D_{1h10}	L_1	L_2	D_{h5}	L	Z	PCD	CVD
1.00	2.0	-	6	42	1	979179	
1.50	3.0	-	6	42	1	977382	
2.00	3.0	6	6	42	1	66785	
2.00 >	3.0	20	6	75	1	970175	
3.00	4.0	6	6	42	1	67540	301958
3.00 >	4.0	6	6	42	2		305549
3.00 >	4.0	15	6	75	2	970176	
3.00 >	4.0	20	6	75	2	970177	
4.00	4.0	8	6	50	1	957593	
4.00 >	6.5	10	6	50	1	67541	
4.00 >	6.5	15	6	75	2	970178	301959
4.00 >	6.5	25	6	75	2	970179	
5.00	5.0	10	6	50	2	957595	
5.00 >	6.5	10	6	50	2	53153	
5.00 >	6.5	35	6	75	2	970166	301960
6.00	6.0	12	6	57	2	976391	301961
6.00 >	8.0	34	6	75	2	976392	
6.00 >	8.0	50	6	100	2	976393	
7.00	8.0	34	8	75	2	976394	301962
8.00	7.0	14	8	63	2	976395	
8.00 >	10.0	34	8	75	2	976396	301963
8.00 >	10.0	50	8	100	2	976397	
8.00 >	10.0	75	8	125	2	976398	
9.00	10.0	35	10	75	2	976399	
10.00	8.0	16	10	75	2	976410	301965
10.00 >	12.0	35	10	75	2	976411	
10.00 >	12.0	75	10	125	2	976412	
11.00	12.0	38	12	83	2	976413	
12.00	10.0	20	12	83	2	976414	301966
12.00 >	12.0	38	12	83	2	976415	
12.00 >	12.0	75	12	125	2	976416	
14.00	12.0	24	14	83	2	976417	338991
14.00 >	12.0	38	14	83	2	976418	
14.00 >	12.0	75	14	125	2	976419	
16.00	14.0	28	16	92	2	976420	338992
16.00 >	14.0	42	16	92	2	976421	
16.00 >	14.0	75	16	125	2	976422	
20.00	18.0	36	20	104	2	976423	
20.00 >	18.0	50	20	125	2	976424	



Sur demande



DIXI 70320-SH PCD

FRAISES HÉMISPHERIQUES
AVEC TROUS DE LUBRIFICATION

Z = 1-2

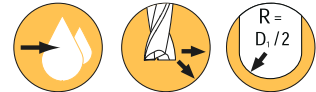

> Ø 6

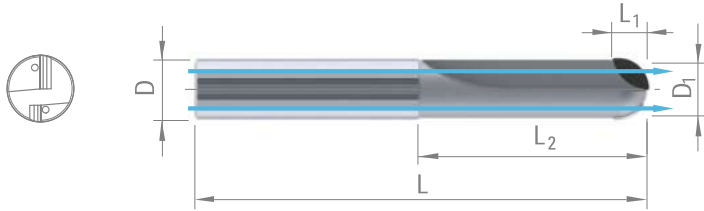

- Alliage Cu
Argent
Or
- Alliage
Cu
difficile
- Alu
4-8%
Si
- Alu
8-13%
Si
- Carbure
Céramique
verte
- Plastique
- Fibre de
carbone

D _{1 h10}	L ₁	D	L ₂	L	Z	PCD
2.00	2.0	6	6.0	42	1	953442
			25.0	75	1	970874
3.00	2.5	6	6.0	42	1	953443
			25.0	75	1	970875
4.00	3.0	6	25.0	75	2	970876
			8.0	50	1	959468
			10.0	50	1	953444
			10.0	50	2	970877
5.00	4.0	6	25.0	75	2	970878
			35.0	75	2	981585
			10.0	50	2	953445
			25.0	75	2	970883
6.00	4.0	6	12.0	57	2	976433
			34.0	75	2	976434
			50.0	100	2	976435
8.00	5.0	8	14.0	63	2	976436
			34.0	75	2	976437
			75.0	125	2	976438
10.00	6.0	10	16.0	72	2	976439
			35.0	75	2	976440
12.00	7.0	12	75.0	125	2	976441
			20.0	83	2	976442
12.00	7.0	12	38.0	83	2	976443
			75.0	125	2	976444
14.00	8.0	14	24.0	83	2	305821
16.00	9.0	16	28.0	92	2	300800
20.00	11.0	20	36.0	104	2	305822



DIXI 70630 PCD

FRAISES EN BOUT DE FINITION
AVEC COUPE AU CENTRE

Z = 1

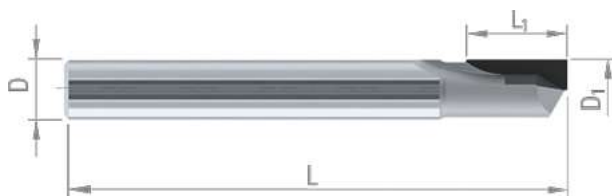

Alliage Cu Argent Or	Alliage Cu difficile	Alu 4-8% Si	Alu 8-13% Si	Graphite
Carbure Céramique verte	Plastique	Fibre de carbone		

$D_{1\ h10}$	L_1	D_{h5}	L	PCD finition	PCD réaffûté
3	6	6	38	381663	381670
4	10	6	50	381665	381671
6	15	6	50	381666	381672
8	19	8	60	381667	381673
10	22	10	60	381668	381675
12	26	12	60	381669	381676

DIXI 7800

FRAISE À SURFACER À PLAQUETTES BRASÉES

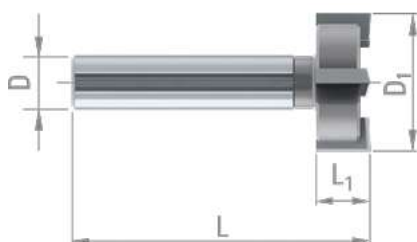
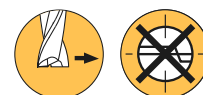

Plastique

$D_{1\pm0.05}$	L_1	D_{h6}	L	Z	CARBURE neuf	CARBURE réaffûté
12	8	6	43	4	381186	381192
20	8	8	43	4	381187	381193
25	8	8	43	5	381188	381194
30	8	8	43	5	381190	381195
35	8	8	43	6	381191	381196

DIXI 81000

TASSEAU PORTE-OUTIL DE FRAISAGE
POUR SURFAÇAGE DE SUPER FINITION

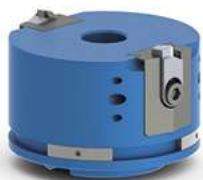
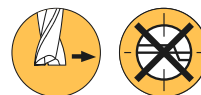

**Tête de surfaçage
avec réglage d'inclinaison**

D ₁	D	L	Art.
60	22	50	996583
85	27	55	962824
100	27	55	964272
125	40	58	994652

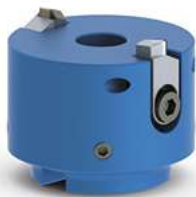

Tête de surfaçage

D ₁	D	L	Art.
40	16	55	970446
50	16	45	971872
60	22	40	962823



**Tête de surfaçage
avec queue de serrage**

D ₁	D	L	Art.
40	12	55	964273

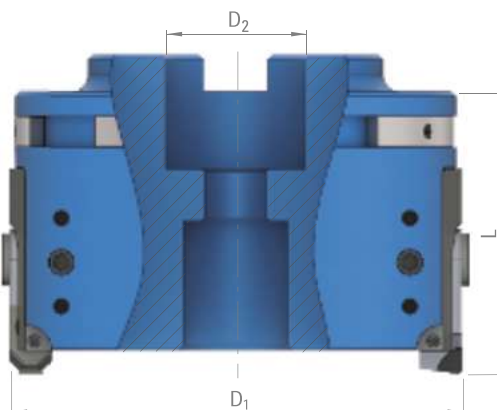

**Insert de finition
(diamant monocristallin)**

Matière à usiner	DIA
Plastique	968111
Aluminium / Cuivre	969556
Titane	968526
Laiton	969557



Insert d'ébauche (PCD)

Matière à usiner	PCD
Toutes matières non-ferreuses	968117

DIXI 20370

CRAYONS Ø 8 x 31
POUR MACHINES BERMAQ

Ref. 1



Ref. 2



Ref. 3



Ref. 4



Description	Matière	Couleur	Art.
Ref. 1 Outil de fraisage ébauche	PCD	noir	968179
Ref. 2 Outil de fraisage finition brillante	PCD	rouge	968181
Ref. 3 Outil de fraisage finition satinée	PCD	vert	974193
Ref. 4 Outil de fraisage finition transparente	DIA	bleu	968178



PINCES DE SERRAGE ER SELON ISO 15488-B



P. 28



ER	D ₁	Plage de serrage	Art.
11	1.0	-	998086
11	1.5	-	998087
11	2.0	-	998088
11	2.5	-	998089
11	3.0	-	998090
11	3.5	-	998091
11	4.0	-	998092
11	4.5	-	998093
11	5.0	-	998094
11	5.5	-	998095
11	6.0	-	998096
11	6.5	-	998097
11	7.0	-	998098
11	7.5	-	346520
11	8.0	-	306711
16	1.0	1.0-0.5	997589
16	2.0	2.0-1.0	997590
16	3.0	3.0-2.0	997591
16	4.0	4.0-3.0	997592
16	5.0	5.0-4.0	997593
16	6.0	6.0-5.0	997594
16	7.0	7.0-6.0	997595
16	8.0	8.0-7.0	997596
16	9.0	9.0-8.0	997597
16	10.0	10.0-9.0	997598
16	11.0	11.0-10.0	997599
16	12.0	12.0-11.0	997600
20	1.0	1.0-0.5	997601
20	2.0	2.0-1.0	997602
20	3.0	3.0-2.0	997603
20	4.0	4.0-3.0	997604
20	5.0	5.0-4.0	997605
20	6.0	6.0-5.0	997606
20	7.0	7.0-6.0	997607
20	8.0	8.0-7.0	997608
20	9.0	9.0-8.0	997609
20	10.0	10.0-9.0	997610
20	11.0	11.0-10.0	997611
20	12.0	12.0-11.0	997612
20	13.0	13.0-12.0	997613
20	14.0	14.0-13.0	997614
20	15.0	15.0-14.0	997615

ER	D ₁	Plage de serrage	Art.
25	2.0	2.0-1.5	997616
25	2.5	2.5-2.0	997617
25	3.0	3.0-2.0	997618
25	4.0	4.0-3.0	997619
25	5.0	5.0-4.0	997620
25	6.0	6.0-5.0	997621
25	7.0	7.0-6.0	997622
25	8.0	8.0-7.0	997623
25	9.0	9.0-8.0	997624
25	10.0	10.0-9.0	997625
25	11.0	11.0-10.0	997626
25	12.0	12.0-11.0	997627
25	13.0	13.0-12.0	997628
25	14.0	14.0-13.0	997629
25	15.0	15.0-16.0	997630
25	16.0	16.0-15.0	997631
32	2.0	2.0-1.5	997632
32	2.5	2.5-2.0	997633
32	3.0	3.0-2.0	997634
32	4.0	4.0-3.0	997635
32	5.0	5.0-4.0	997636
32	6.0	6.0-5.0	997637
32	7.0	7.0-6.0	997638
32	8.0	8.0-7.0	997639
32	9.0	9.0-8.0	997640
32	10.0	10.0-9.0	997641
32	11.0	11.0-10.0	997642
32	12.0	12.0-11.0	997643
32	13.0	13.0-12.0	997644
32	14.0	14.0-13.0	997645
32	15.0	15.0-14.0	997646
32	16.0	16.0-15.0	997647
32	17.0	17.0-16.0	997648
32	18.0	18.0-17.0	997649
32	19.0	19.0-18.0	997650
32	20.0	20.0-19.0	997651



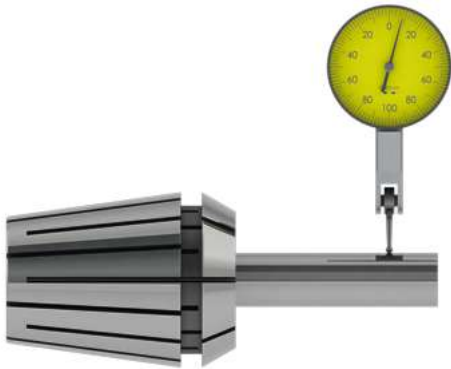

BONNE CONCENTRICITÉ

Longévité de l'outil • Etat de surface • Précision

D ₁	L	
2-3	10	0,01
4-5-6	16	0,01
7-8-10	25	0,01
12.7	40	0,01

PRÉCAUTION DE SERRAGE

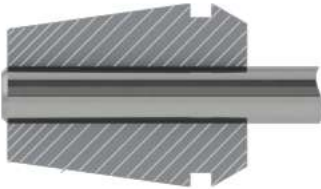

**Serrer la queue de l'outil sur toute
la longueur de la pince**

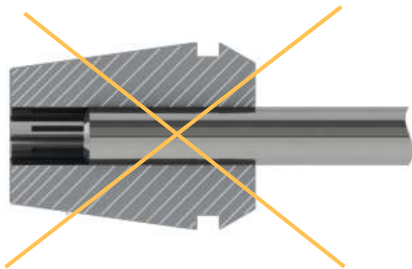

MONTAGE DE LA PINCE DANS L'ECROU

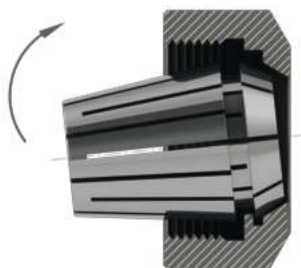

Rainure d'extraction

Anneau excentrique

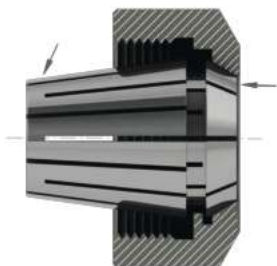

PROFIL DE L'ENTREPRISE



DIXI POLYTOOL S.A.

DIXI Polytool S.A., créateur d'outils de coupe de précision en carbure monobloc, diamant, outils de forme et alésoirs de précision, est installé au Locle (Suisse) depuis 1946. Ses locaux ont été totalement rénovés et agrandis en 2014.

La mise en place d'un projet Lean depuis 2013 et des investissements conséquents dans l'appareil de production viennent appuyer les efforts des 250 collaborateurs.

Soucieux de garantir la qualité de ses produits tout en préservant l'environnement, DIXI Polytool S.A. a mis en place un système de management certifié conforme aux normes ISO 9001 et ISO 14001.

UNE ATTITUDE ÉCOLOGIQUEMENT RESPONSABLE

Depuis plusieurs années, DIXI Polytool S.A. s'est engagé à n'utiliser que du papier recyclé à 100% et l'encre pour les imprimés n'est constituée que de colorants naturels.

Précurseur également dans ce domaine, depuis janvier 2015, DIXI Polytool S.A. consomme exclusivement de l'énergie verte pour tout l'entretien du bâtiment et le fonctionnement de la fabrication.

Notre engagement pour le développement durable...



polytool

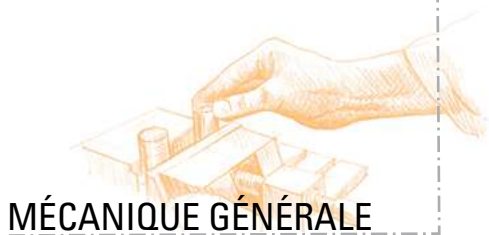

DIXI POLYTOOL S.A.
Av. du Technicum 37
CH-2400 Le Locle

T +41 (0)32 933 54 44
F +41 (0)32 931 89 16

dixipoly@dixi.ch

www.dixipolytool.com

DIXI POLYTOOL S.A.R.L.
ZAC de Rubellin
FR-73730 Cevins

T +33 (0)4 79 38 25 92
F +33 (0)4 79 38 26 65

dixifrance@dixi.com

www.dixipolytool.com

