

PRECISION REAMERS
ESCARIADORES DE PRECISIÓN
精密铰刀

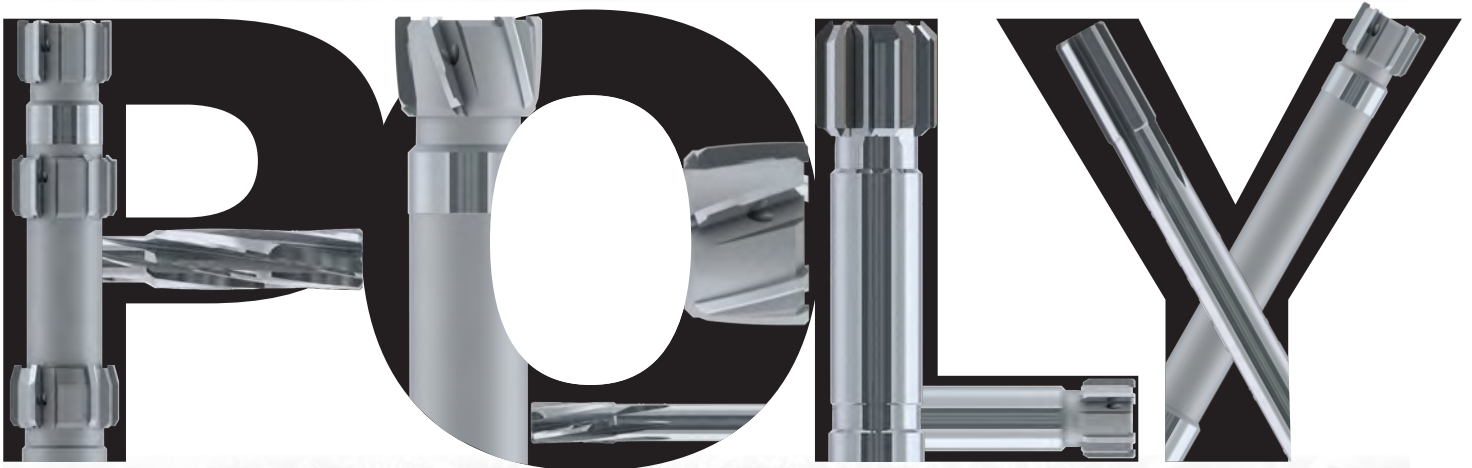

18 EN - ES - CN

swiss
made 
since
1946



Enjoy Swiss Precision

www.dixipolytool.com

Tungsten carbide and diamond precision tools
Herramientas de precisión en metal duro y diamante
 硬质合金和金刚石精密刀具

Tools dedicated to the WM-701S machine
Herramientas específicas para máquina WM-701S
 专用于威力铭WM-701S机床的刀具

Thread gauges
Calibres de precisión
 螺纹规



PCD and diamond tools
Herramientas de diamante y PCD
 PCD和金刚石刀具

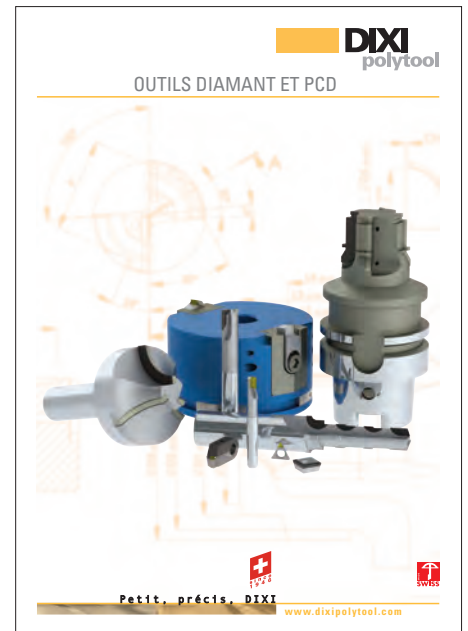

DIXI POLYTOOL, partner of Swiss athlete KARIEM HUSSEIN
DIXI POLYTOOL es sponsor del atleta suizo KARIEM HUSSEIN
 DIXI POLYTOOL, 瑞士运动员KARIEM HUSSEIN的合作伙伴



SOLID CARBIDE & TIPPED SOLID REAMERS
ESCARIADORES EN CARBURO Y FIJOS
硬质合金&整体式铰刀



9

EXPANDABLE TIPPED REAMERS
ESCARIADORES EXPANSIBLES
内涨式铰刀



31

TIPPED SOLID & EXPANDABLE HEADS
CABEZALES FIJOS & EXPANSIBLES
内涨式&非内涨式铰削头



41

COMPENSATION HOLDERS & HOLDERS
PORTAHERRAMIENTAS DE COMPENSACIÓN
& *PORTAHERRAMIENTAS*
刀柄&补偿式刀柄



51

CUTTING CONDITIONS
CONDICIONES DE CORTE
切削状况



63

RETIPPING / TECHNOLOGY / CUTTING GEOMETRY
REGENERADO / TECNOLOGÍA / GEOMETRÍA
DE CORTE
切削几何角度



69

SOLID CARBIDE REAMERS
ESCARIADORES EN METAL DURO
 整体硬质合金铰刀
 Ø 0.40 - Ø 12.02 mm

FROM STOCK
EN STOCK
 库存

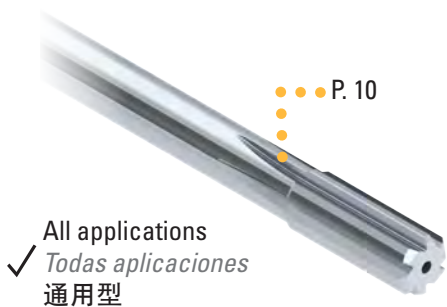

TIPPED SOLID REAMERS
ESCARIADORES FIJOS
 非内涨式铰刀
 Ø 5.80 - Ø 130.00 mm

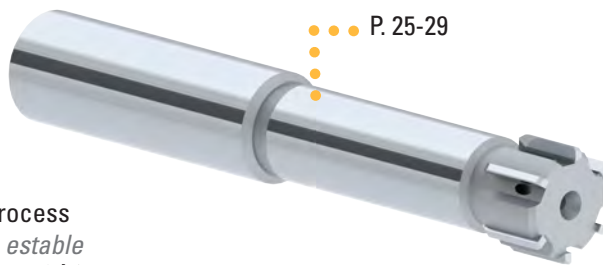

TIPPED EXPANDABLE REAMERS
ESCARIADORES EXPANSIBLES
 内涨式铰刀
 Ø 5.80 - Ø 55.00 mm

FROM STOCK
EN STOCK
 库存

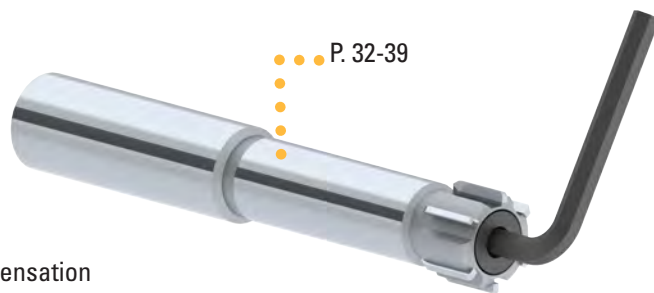

TOOL HOLDER + HEAD (Ø 9.60 - Ø 55.00) + SCREW
PORTAHERRAMIENTA + CABEZA (Ø 9.60 - Ø 55.00) + TORNILLO
 刀柄+刀头(Ø 9.60 - Ø 55.00)+螺丝



SELECTION GUIDE ACCORDING TO TOOL DIAMETER

GUIA DE SELECCIÓN DE ACUERDO CON EL DIÁMETRO DE LA HERRAMIENTA







标准铰刀总览

FROM STOCK
EN STOCK
库存



ON REQUEST
SOBRE DEMANDA
定制刀具



TOOLS HERRAMIENTAS 刀具	page página 页	Ø 0.40	Ø 5.80	Ø 9.60	Ø 12.02	Ø 20.00	Ø 24.00	Ø 45.00	Ø 55.00	Ø 130.00
 SOLID CARBIDE REAMERS <i>ESCARIADORES EN CARBURO</i> 硬质合金铰刀	10 - 24		FROM STOCK					ON REQUEST		
 TIPPED SOLID REAMERS <i>ESCARIADORES FIJOS</i> 非内涨式铰刀	25 - 29		ON REQUEST							
 TIPPED EXPANDABLE REAMERS <i>ESCARIADORES EXPANSIBLES</i> 内涨式铰刀	32 - 39		FROM STOCK					ON REQUEST		
 TIPPED SOLID HEADS <i>CABEZALES FIJOS</i> 非内涨式铰削头	42 - 43		ON REQUEST							
 TIPPED EXPANDABLE HEADS <i>CABEZALES EXPANSIBLES</i> 内涨式铰削头	44 - 45		ON REQUEST							
 SOLID CARBIDE HEADS <i>CABEZALES EN CARBURO</i> 整硬铰削头	46 - 47		ON REQUEST							



RETIPPING SERVICE
SERVICIO DE REGENERACIÓN
重磨

Economical
✓ *Económico*
经济

All manufacturers
✓ *Todos los fabricantes*
所有其他品牌的铰刀

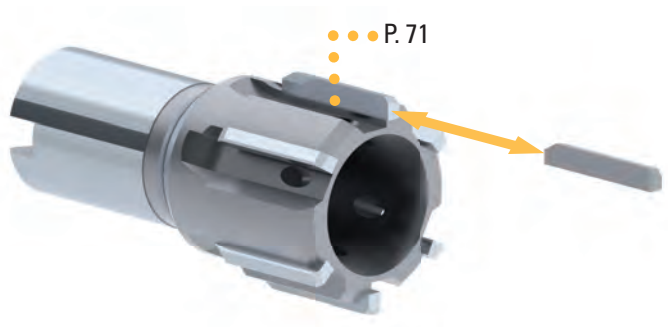

CUSTOMIZED REAMERS
ESCARIADORES SOBRE DEMANDA
非标定制铰刀



SEND US YOUR INQUIRY TO *ENVÍENOS SU SOLICITUD A* 请将您的需要，发送至
dixipoly@dixi.ch



SERVICE & TECHNICAL SUPPORT
SERVICIO & SOPORTE TÉCNICO
服務和技術支持

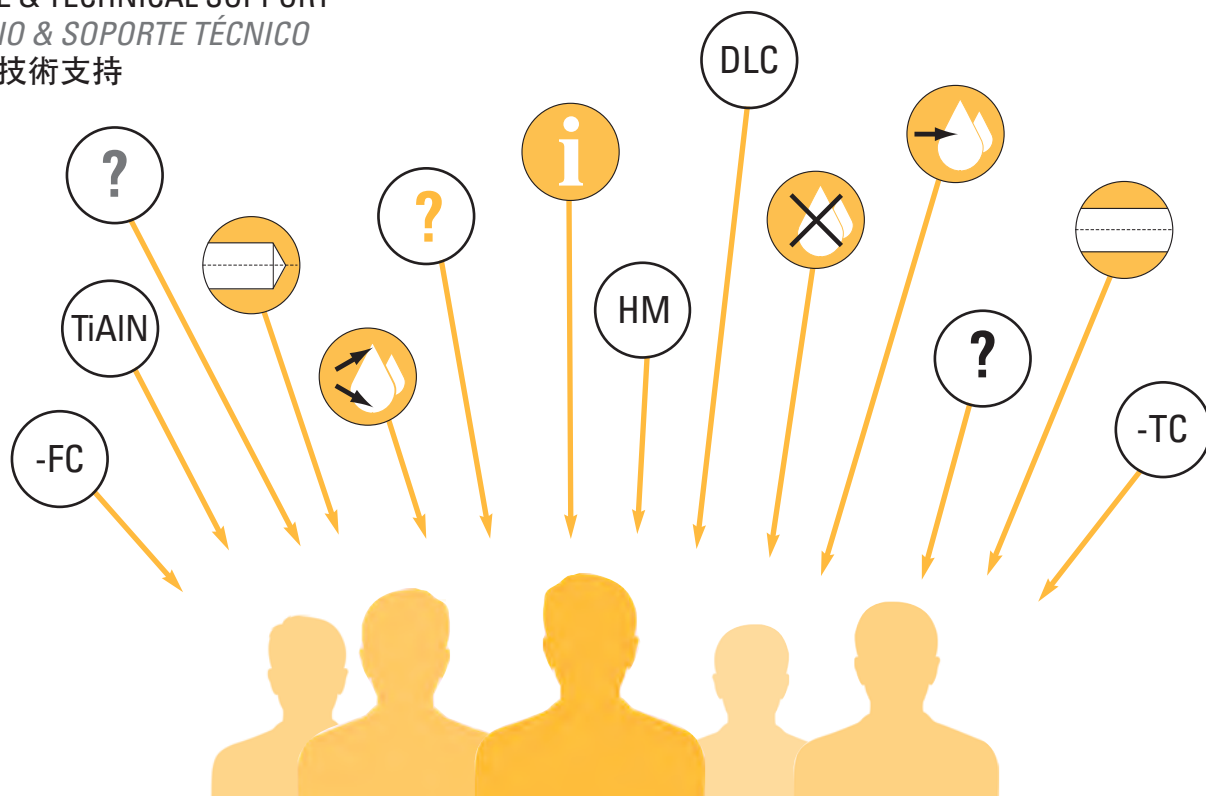

SEND US YOUR INQUIRY TO *ENVÍENOS SU SOLICITUD A* 请将您的需要，发送至
dixipoly@dixi.ch

SISTER COMPANIES & AGENTS
FILIALES & AGENTES
子公司和分公司

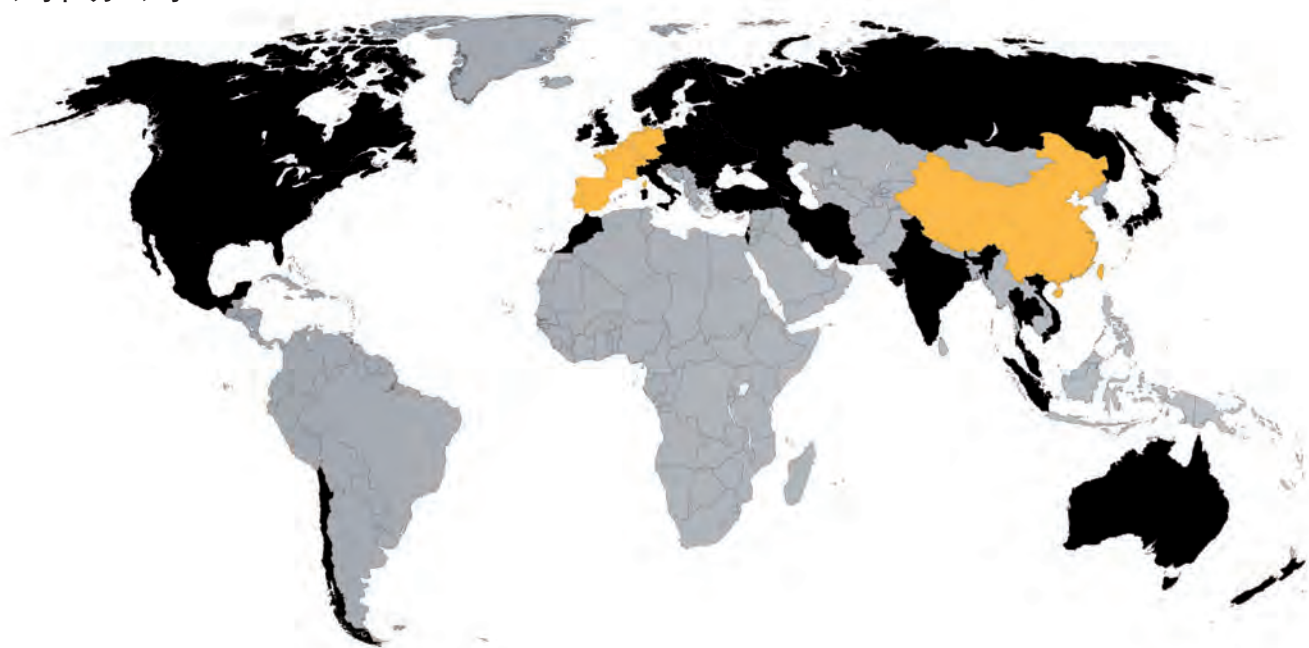

5 sister companies
filiales
姊妹公司

40 representative countries
representantes de países
国家代表处

75 years experience
años de experiencia
年经验



APPLICATIONS FIELDS, MATERIALS, DIN DESIGNATION
CAMPOS DE APLICACIÓN, MATERIALES, DESIGNACIÓN DIN
应用范围，材料，DIN材料型号

Materials to be machined























































Materiales a mecanizar

被加工材料

		DIN	W. Nr.	Rm	HB / HRC
P	Unalloyed steel / Low alloyed steel <i>Acero no aleado / Acero de baja aleación</i> 非合金钢/低合金钢	St37-2 / S235JR 9SMn28 / 11SMn30 St52-2 / E295 9SMnPb28 / 11SMnPb30	1.0037 1.0715 1.0050 1.0718	< 600 N/mm ²	
P	Unalloyed steel / Low alloyed steel <i>Acero no aleado / Acero de baja aleación</i> 非合金钢/低合金钢	42CrMo4 CK60 / C60E	1.7225 1.1221	600 – 1500 N/mm ²	
P	High alloyed steel <i>Acero de alta aleación</i> 高合金钢/不锈钢	X6CrMo4 / 6CrMo15-5 X165Cr-MoV12	1.2341 1.2601	700 – 1500 N/mm ²	
M	Stainless steel <i>Acero inoxidable</i> 不锈钢, 耐热钢	X2CrNi189 / X2CrNi19-11 Mo1810 / X5CrNiMo17-12-2 X2CrNiMo18-14-3 / 316L X8CrNb17 / X3CrNb17	1.4306 1.4401 1.4435 1.4511	400 – 700 N/mm ²	
M	DUPLEX stainless steel <i>Acero inox. DUPLEX, acero inox. austenítico sin nickel</i> 双相不锈钢	X10CrAlSi7 X8CrS-38-18	1.4713 1.4862	> 800 N/mm ²	
H	Hardened steels <i>Aceros templados</i> 淬硬钢			> 1500 N/mm ²	45 - 65 HRC
K	Grey cast iron <i>Fundición gris</i> 灰口铸铁	GG-25 / EN-GJL-250 GG-35 / EN-GJL-350	0.6025 0.6035		< 250 HB
K	Alloyed grey cast iron <i>Fundición gris aleada</i> 合金灰口铸铁	GG-NiCr202 / GJL-NiCr20-2	0.6660		> 250 HB
K	Spheroidal graphite cast iron ferritic / perlitic <i>Fundición de grafito esferoidal ferrítica / perlítica</i> 球墨铸铁 铁素体/珠光体	GGG-40 / EN-GJS-400-15 GGG-50 / GGG-55 GTW-55	0.7040 0.7050 0.8055		< 600 HB
K	Spheroidal graphite cast iron / Perlitic malleable iron <i>Fundición de grafito esferoidal ferrítico / Fundición perlítica maleable</i> 球墨铸铁/珠光体马氏体	GGG-60 / EN-GJS-600-3 GTS-65	0.7060 0.8165		> 600 HB
K	Alloyed spheroidal graphite cast iron / Vermicular cast <i>Fundición de grafito esferoidal / Fundición vermicular</i> 合金球墨铸铁/蠕墨铸铁	GGG NiCr20-2 GGV Ti <0.2 GGV Ti >0.2	0.7661		
S	Special alloys / Heat resistant stainless steel <i>Superaleaciones / Acero inox. refractario</i> 特殊合金/耐热不锈钢	Inconel Nimonic Hastelloy		> 1500 N/mm ²	
S	Titanium / Titanium alloys <i>Titanio / Aleaciones de titanio</i> 钛, 钛合金	TiAl55n2	3.7114		
N	Copper alloy (brass - bronze) <i>Aleaciones de cobre (latón y bronce)</i> 铜合金	CuZn36Pb3 G-CuPb15Sn	2.1182 2.1182		
N	Copper alloy / Aluminium bronze <i>Aleaciones de cobre / Bronce de aluminio</i> 铜合金/铜铝合金	CuZn40Al1 E-Cu57	2.0550 2.0060		
N	Cast aluminium alloy <8 % Si / Magnesium alloy <i>Aleación de aluminio <8 % Si / Aleación de magnesio</i> 铸铝合金<8 % 硅 / 镁合金	G-ALMg5	3.3561		
N	Cast aluminium alloy >8 % Si <i>Aleación de aluminio >8 % Si</i> 铸铝合金>8 % 硅	G-AISi9Mg G-AISi10Mg	3.2373 3.2381		



HM Carbide **x** Inapplicable  Good  Excellent
 Carbuo No aplicable *Bueno* *Excelente*
 硬质合金 不适合 好 非常适合

HM	HM + TiAlN	HM + POLY-CUT	HM + C-TOP	HM + DLC	CERMET
				x	
				x	
				x	
				x	x
				x	x
				x	x
				x	
				x	
				x	
				x	
				x	
				x	x
				x	x
					
					
					
					



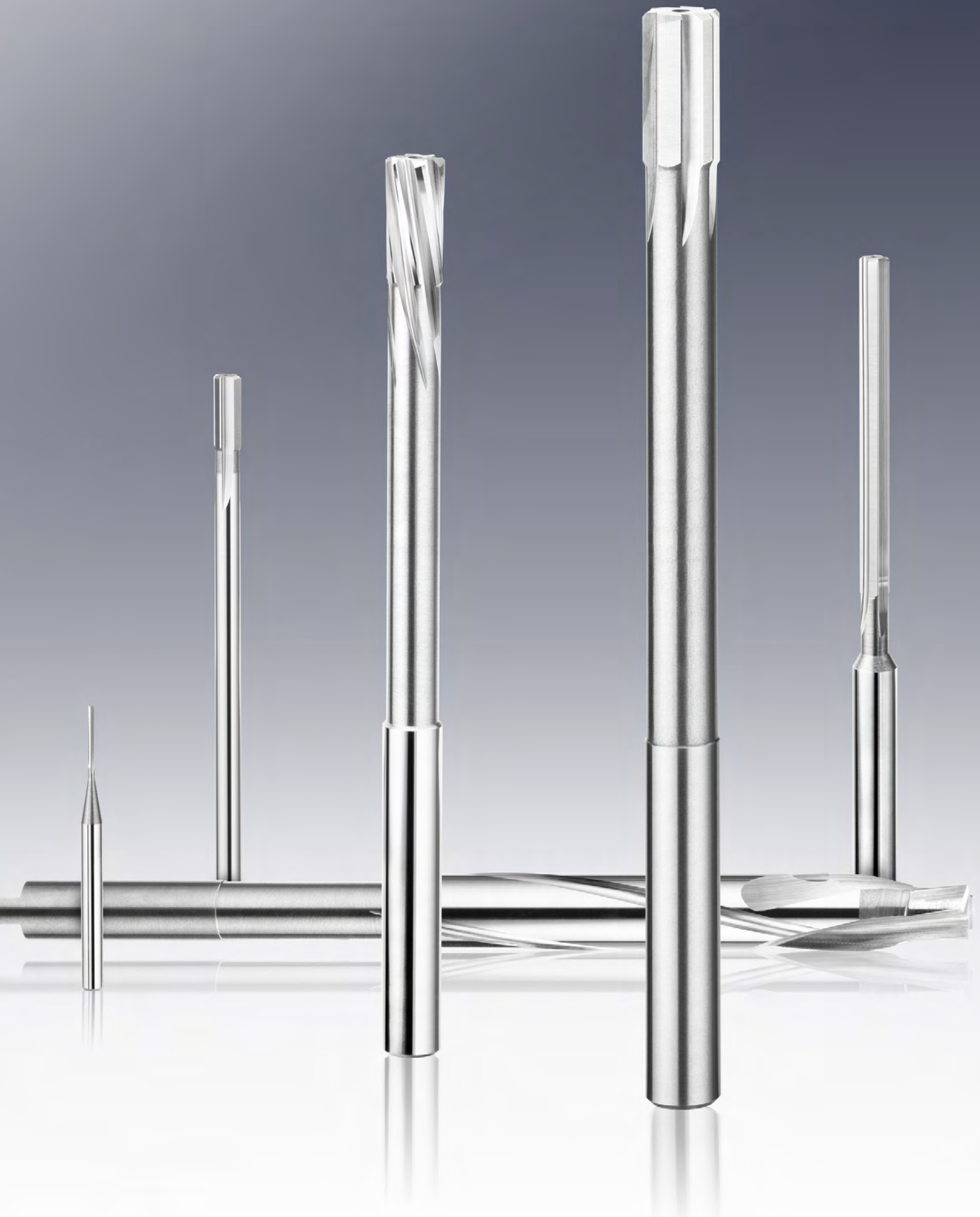

SOLID CARBIDE & TIPPED SOLID REAMERS
 ESCARIADORES EN CARBURO Y FIJOS
 硬质合金&整体式铰刀



SOLID CARBIDE STRAIGHT FLUTE REAMERS
 ESCARIADORES DE DIENTES RECTOS DE CARBURO SÓLIDO
 整体硬质合金直槽铰刀

10

FROM STOCK
 EN STOCK
 库存



SOLID CARBIDE REAMERS, RIGHT-HAND HELIX
 ESCARIADORES DE CARBURO MONOBLOC, HÉLICE A DERECHA
 整体硬质合金铰刀, 右手切削

17

FROM STOCK
 EN STOCK
 库存



SOLID CARBIDE REAMERS, LEFT-HAND HELIX
 ESCARIADORES DE CARBURO MONOBLOC, HÉLICE A IZQUIERDA
 整体硬质合金铰刀, 左手切削

18

FROM STOCK
 EN STOCK
 库存



SHORT TIPPED SOLID REAMERS
 ESCARIADORES FIJOS CORTOS SOLDADOS
 非内涨式短型铰刀

25



SHORT TIPPED SOLID REAMERS, LEFT-HAND HELIX
 ESCARIADORES DE DIENTES A IZQUIERDA FIJOS CORTOS
 非内涨式铰刀, 左手切削

25



LONG TIPPED SOLID REAMERS
 ESCARIADORES FIJOS LARGOS SOLDADOS
 非内涨式加长型铰刀

26



SHORT TIPPED SOLID REAMERS FOR MATERIALS > 45 HRC
 ESCARIADORES FIJOS CORTOS SOLDADOS PARA MATERIALES > 45 HRC
 非内涨式铰刀用于加工材料 > 45 HRC

27



LONG TIPPED SOLID REAMERS FOR MATERIALS > 45 HRC
 ESCARIADORES FIJOS LARGOS SOLDADOS PARA MATERIALES > 45 HRC
 非内涨式铰刀用于加工材料 > 45 HRC

28

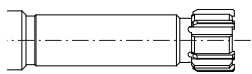

TIPPED SOLID REAMERS ON REQUEST
 ESCARIADORES FIJOS SOLDADOS SOBRE DEMANDA
 非标定制刀具

29

POLY 4001 - 4001-TC

SOLID CARBIDE STRAIGHT FLUTE REAMERS

ESCARIADORES DE DIENTES RECTOS DE CARBURO SÓLIDO

整体硬质合金直槽铰刀



P. 64



> Ø 2.98

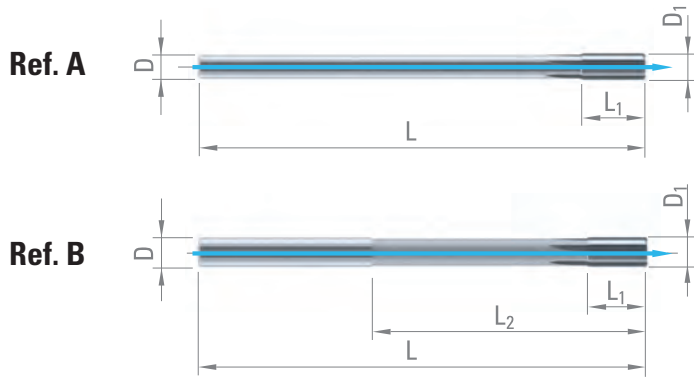
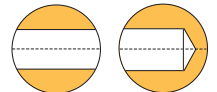

**FROM STOCK
EN STOCK
库存**

D nom. H7	D ₁ ± 1.5µm	L ₁	L ₂	D _{h5}	L	Z	Ref.	HM
0.40	(0.407)	3	5	3	38	3	B	959801
0.41	(0.417)	3	5	3	38	3	B	964623
0.42	(0.427)	3	5	3	38	3	B	959802
0.43	(0.437)	3	5	3	38	3	B	978100
0.44	(0.447)	3	5	3	38	3	B	959803
0.45	(0.457)	3	5	3	38	3	B	954360
0.46	(0.467)	3	5	3	38	3	B	959804
0.47	(0.477)	3	5	3	38	3	B	963057
0.48	(0.487)	3	5	3	38	3	B	959805
0.49	(0.497)	3	5	3	38	3	B	954359
0.50	(0.507)	3	5	3	38	3	B	959662
0.51	(0.517)	4	6	3	38	3	B	200007
0.52	(0.527)	4	6	3	38	3	B	200000
0.53	(0.537)	4	6	3	38	3	B	200004
0.54	(0.547)	4	6	3	38	3	B	200005
0.55	(0.557)	4	6	3	38	3	B	200001
0.56	(0.567)	4	6	3	38	3	B	966312
0.57	(0.577)	4	6	3	38	3	B	326970
0.58	(0.587)	4	6	3	38	3	B	200003
0.59	(0.597)	4	6	3	38	3	B	200006
0.60	(0.607)	4	6	3	38	3	B	200002
0.61	(0.617)	4	7	3	38	3	B	964889
0.62	(0.627)	4	7	3	38	3	B	200010
0.63	(0.637)	4	7	3	38	3	B	965815
0.64	(0.647)	4	7	3	38	3	B	200015
0.65	(0.657)	4	7	3	38	3	B	200008
0.66	(0.667)	4	7	3	38	3	B	200012
0.67	(0.677)	4	7	3	38	3	B	200013
0.68	(0.687)	4	7	3	38	3	B	200011
0.69	(0.697)	4	7	3	38	3	B	200014
0.70	(0.707)	4	7	3	38	3	B	200009
0.71	(0.717)	4	8	3	38	3	B	955902
0.72	(0.727)	4	8	3	38	3	B	200018
0.73	(0.737)	4	8	3	38	3	B	959571
0.74	(0.747)	4	8	3	38	3	B	200022
0.75	(0.757)	4	8	3	38	3	B	200016
0.76	(0.767)	4	8	3	38	3	B	961872
0.77	(0.777)	4	8	3	38	3	B	200020
0.78	(0.787)	4	8	3	38	3	B	200019
0.79	(0.797)	4	8	3	38	3	B	200021
0.80	(0.807)	4	8	3	38	3	B	200017

D nom. H7	D ₁ ± 1.5µm	L ₁	L ₂	D _{h5}	L	Z	Ref.	HM
0.81	(0.817)	5	9	3	38	3	B	964624
0.82	(0.827)	5	9	3	38	3	B	200025
0.83	(0.837)	5	9	3	38	3	B	200029
0.84	(0.847)	5	9	3	38	3	B	200028
0.85	(0.857)	5	9	3	38	3	B	200023
0.86	(0.867)	5	9	3	38	3	B	200030
0.87	(0.877)	5	9	3	38	3	B	200031
0.88	(0.887)	5	9	3	38	3	B	200026
0.89	(0.897)	5	9	3	38	3	B	200027
0.90	(0.907)	5	9	3	38	3	B	200024
0.91	(0.917)	5	10	3	38	3	B	200039
0.92	(0.927)	5	10	3	38	3	B	200035
0.93	(0.937)	5	10	3	38	3	B	960023
0.94	(0.947)	5	10	3	38	3	B	963188
0.95	(0.957)	5	10	3	38	3	B	200034
0.96	(0.967)	5	10	3	38	3	B	200036
0.97	(0.977)	5	10	3	38	3	B	200037
0.98	(0.987)	5	10	3	38	3	B	200032
0.99	(0.997)	5	10	3	38	3	B	200033
1.00	(1.007)	5	10	3	38	3	B	200038
1.01	(1.017)	5	11	3	38	3	B	959800
1.02	(1.027)	5	11	3	38	3	B	200040
1.03	(1.037)	5	11	3	38	3	B	966908
1.04	(1.047)	5	11	3	38	3	B	962626
1.05	(1.057)	5	11	3	38	3	B	200041
1.06	(1.067)	5	11	3	38	3	B	966799
1.07	(1.077)	5	11	3	38	3	B	968047
1.08	(1.087)	5	11	3	38	3	B	200042
1.09	(1.097)	5	12	3	38	3	B	955685
1.10	(1.107)	5	12	3	38	3	B	200045
1.11	(1.117)	5	12	3	38	3	B	951529
1.12	(1.127)	5	12	3	38	3	B	951598
1.13	(1.137)	5	12	3	38	3	B	968503
1.14	(1.147)	5	12	3	38	3	B	968504
1.15	(1.157)	5	12	3	38	3	B	200043
1.16	(1.167)	5	12	3	38	3	B	967147
1.17	(1.177)	5	12	3	38	3	B	956647
1.18	(1.187)	5	12	3	38	3	B	67307
1.19	(1.197)	5	12	3	38	3	B	960753
1.20	(1.207)	5	12	3	38	3	B	200044
1.21	(1.217)	6	13	3	38	3	B	67308

All Ø with tolerance ±2µm available through our express-service

Cualquier diámetro disponible sobre demanda con tolerancia ±2µm a través de nuestro servicio rápido

通过我们特殊定制，所有直径尺寸公差可达±2 µm

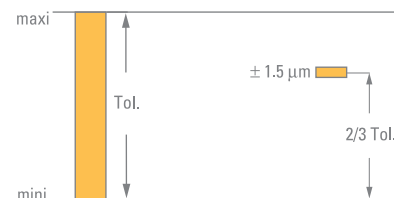

P. 73



POLY 4001 - 4001-TC



P. 64



> Ø 2.98

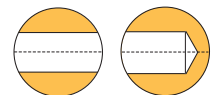

Ref. A



Ref. B

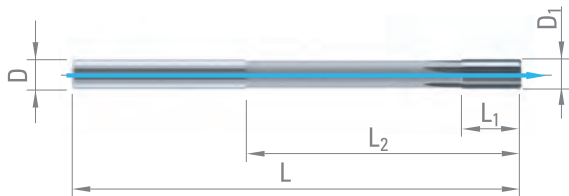

FROM STOCK
EN STOCK
库存

D nom. H7	D ₁ ± 1.5µm	L ₁	L ₂	D _{h5}	L	Z	Ref.	HM
1.22	(1.227)	6	13	3	38	3	B	968605
1.23	(1.237)	6	13	3	38	3	B	968606
1.24	(1.247)	6	13	3	38	3	B	968607
1.25	(1.257)	6	13	3	38	3	B	200046
1.26	(1.267)	6	13	3	38	3	B	968608
1.27	(1.277)	6	13	3	38	3	B	964024
1.28	(1.287)	6	13	3	38	3	B	200048
1.29	(1.297)	6	13	3	38	3	B	950915
1.30	(1.307)	6	13	3	38	3	B	200047
1.31	(1.317)	6	13	3	38	3	B	959472
1.32	(1.327)	6	13	3	38	3	B	961369
1.33	(1.337)	6	13	3	38	3	B	961963
1.34	(1.347)	6	13	3	38	3	B	326971
1.35	(1.357)	6	13	3	38	3	B	200049
1.36	(1.367)	6	13	3	38	3	B	968242
1.37	(1.377)	6	13	3	38	3	B	960591
1.38	(1.387)	6	13	3	38	3	B	966541
1.39	(1.397)	6	13	3	38	3	B	960202
1.40	(1.407)	6	13	3	38	3	B	200050
1.41	(1.417)	7	15	3	38	3	B	957425
1.42	(1.427)	7	15	3	38	3	B	955757
1.43	(1.437)	7	15	3	38	3	B	955746
1.44	(1.447)	7	15	3	38	3	B	961345
1.45	(1.457)	7	15	3	38	3	B	200053
1.46	(1.467)	7	15	3	38	3	B	66791
1.47	(1.477)	7	15	3	38	3	B	961456
1.48	(1.487)	7	15	3	38	3	B	200051
1.49	(1.497)	7	15	3	38	3	B	200052
1.50	(1.507)	7	15	3	38	3	B	200054
1.51	(1.517)	7	15	3	50	3	B	200104
1.52	(1.527)	7	15	3	50	3	B	200105
1.53	(1.537)	7	15	3	50	3	B	960836
1.54	(1.547)	7	15	3	50	3	B	63795
1.55	(1.557)	7	15	3	50	3	B	200125
1.56	(1.567)	7	15	3	50	3	B	973910
1.57	(1.577)	7	15	3	50	3	B	963006
1.58	(1.587)	7	15	3	50	3	B	961472
1.59	(1.597)	7	15	3	50	3	B	959620
1.60	(1.607)	7	15	3	50	3	B	200111
1.61	(1.617)	7	16	3	50	3	B	59391
1.62	(1.627)	7	16	3	50	3	B	955366
1.63	(1.637)	7	16	3	50	3	B	326972
1.64	(1.647)	7	16	3	50	3	B	326973
1.65	(1.657)	7	16	3	50	3	B	200124
1.66	(1.667)	7	16	3	50	3	B	991141
1.67	(1.677)	7	16	3	50	3	B	965451
1.68	(1.687)	7	16	3	50	3	B	326974

D nom. H7	D ₁ ± 1.5µm	L ₁	L ₂	D _{h5}	L	Z	Ref.	HM
1.69	(1.697)	7	16	3	50	3	B	952172
1.70	(1.707)	7	16	3	50	3	B	200126
1.71	(1.717)	7	17	3	50	3	B	66359
1.72	(1.727)	7	17	3	50	3	B	959573
1.73	(1.737)	7	17	3	50	3	B	326975
1.74	(1.747)	7	17	3	50	3	B	968498
1.75	(1.757)	7	17	3	50	3	B	200127
1.76	(1.767)	7	17	3	50	3	B	974605
1.77	(1.777)	7	17	3	50	3	B	961458
1.78	(1.787)	7	17	3	50	3	B	63459
1.79	(1.797)	7	17	3	50	3	B	200146
1.80	(1.807)	7	17	3	50	3	B	200112
1.81	(1.817)	8	17	3	50	3	B	962183
1.82	(1.827)	8	17	3	50	3	B	960953
1.83	(1.837)	8	17	3	50	3	B	951867
1.84	(1.847)	8	17	3	50	3	B	326976
1.85	(1.857)	8	17	3	50	3	B	200113
1.86	(1.867)	8	17	3	50	3	B	964274
1.87	(1.877)	8	17	3	50	3	B	326977
1.88	(1.887)	8	17	3	50	3	B	954731
1.89	(1.897)	8	17	3	50	3	B	200137
1.90	(1.907)	8	17	3	50	3	B	200114
1.91	(1.917)	8	18	3	50	3	B	982028
1.92	(1.927)	8	18	3	50	3	B	326978
1.93	(1.937)	8	18	3	50	3	B	326979
1.94	(1.947)	8	18	3	50	3	B	67301
1.95	(1.957)	8	18	3	50	3	B	200115
1.96	(1.967)	8	18	3	50	3	B	200145
1.97	(1.977)	8	18	3	50	3	B	200106
1.98	(1.987)	8	18	3	50	3	B	200107
1.99	(1.997)	8	18	3	50	3	B	200108
2.00	(2.007)	8	18	3	50	3	B	200102
2.01	(2.017)	8	18	3	50	3	B	200109
2.02	(2.027)	8	18	3	50	3	B	200110
2.03	(2.037)	8	18	3	50	3	B	63271
2.04	(2.047)	8	18	3	50	3	B	200147
2.05	(2.057)	8	18	3	50	3	B	200121
2.06	(2.067)	8	18	3	50	3	B	954744
2.07	(2.077)	8	18	3	50	3	B	63796
2.08	(2.087)	8	18	3	50	3	B	57717
2.09	(2.097)	8	18	3	50	3	B	957058
2.10	(2.107)	8	18	3	50	3	B	200144
2.11	(2.117)	8	18	3	50	3	B	952428
2.12	(2.127)	8	18	3	50	3	B	952429
2.13	(2.137)	8	18	3	50	3	B	967590
2.14	(2.147)	8	18	3	50	3	B	968815
2.15	(2.157)	8	18	3	50	3	B	200120



POLY 4001 - 4001-TC



P. 64

> Ø 2.98

FROM STOCK
EN STOCK
库存

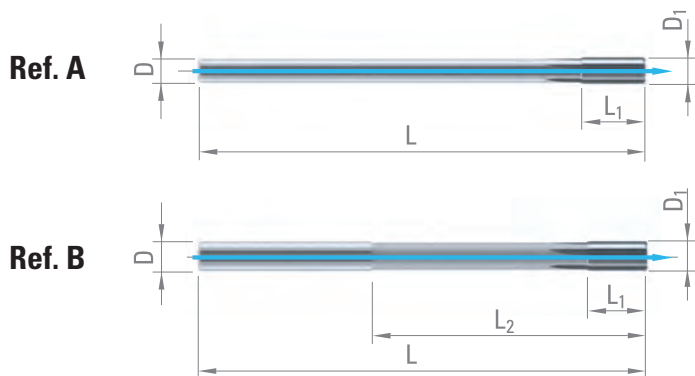

D nom. H7	D ₁ ± 1.5µm	L ₁	L ₂	D _{h5}	L	Z	Ref.	HM
2.16	(2.167)	8	18	3	50	3	B	968156
2.17	(2.177)	8	18	3	50	3	B	959096
2.18	(2.187)	8	18	3	50	3	B	968449
2.19	(2.197)	8	18	3	50	3	B	952213
2.20	(2.207)	8	18	3	50	3	B	200139
2.21	(2.217)	8	18	3	50	3	B	968816
2.22	(2.227)	8	18	3	50	3	B	953362
2.23	(2.237)	8	18	3	50	3	B	326980
2.24	(2.247)	8	18	3	50	3	B	326981
2.25	(2.257)	8	18	3	50	3	B	200119
2.26	(2.267)	8	18	3	50	3	B	326982
2.27	(2.277)	8	18	3	50	3	B	956015
2.28	(2.287)	8	18	3	50	3	B	326983
2.29	(2.297)	8	18	3	50	3	B	985826
2.30	(2.307)	8	18	3	50	3	B	200131
2.31	(2.317)	10	20	3	50	3	B	951944
2.32	(2.327)	10	20	3	50	3	B	200135
2.33	(2.337)	10	20	3	50	3	B	957326
2.34	(2.347)	10	20	3	50	3	B	956298
2.35	(2.357)	10	20	3	50	3	B	200130
2.36	(2.367)	10	20	3	50	3	B	955027
2.37	(2.377)	10	20	3	50	3	B	958068
2.38	(2.387)	10	20	3	50	3	B	962361
2.39	(2.397)	10	20	3	50	3	B	965907
2.40	(2.407)	10	20	3	50	3	B	200129
2.41	(2.417)	10	20	3	50	3	B	950038
2.42	(2.427)	10	20	3	50	3	B	950039
2.43	(2.437)	10	20	3	50	3	B	955020
2.44	(2.447)	10	20	3	50	3	B	962239
2.45	(2.457)	10	20	3	50	3	B	200128
2.46	(2.467)	10	20	3	50	3	B	326984
2.47	(2.477)	10	20	3	50	3	B	959535
2.48	(2.487)	10	20	3	50	3	B	200140
2.49	(2.497)	10	20	3	50	3	B	200141
2.50	(2.507)	10	20	3	50	3	B	200103
2.51	(2.517)	10	20	3	61	4	B	200142
2.52	(2.527)	10	20	3	61	4	B	200143
2.53	(2.537)	10	20	3	61	4	B	954733
2.54	(2.547)	10	20	3	61	4	B	955042
2.55	(2.557)	10	20	3	61	4	B	200118
2.56	(2.567)	10	20	3	61	4	B	326985
2.57	(2.577)	10	20	3	61	4	B	326986
2.58	(2.587)	10	20	3	61	4	B	958772
2.59	(2.597)	10	20	3	61	4	B	971141
2.60	(2.607)	10	20	3	61	4	B	200117
2.61	(2.617)	10	25	3	61	4	B	970909
2.62	(2.627)	10	25	3	61	4	B	952158

D nom. H7	D ₁ ± 1.5µm	L ₁	L ₂	D _{h5}	L	Z	Ref.	HM
2.63	(2.637)	10	25	3	61	4	B	326987
2.64	(2.647)	10	25	3	61	4	B	962551
2.65	(2.657)	10	25	3	61	4	B	200116
2.66	(2.667)	10	25	3	61	4	B	954075
2.67	(2.677)	10	25	3	61	4	B	200136
2.68	(2.687)	10	25	3	61	4	B	954450
2.69	(2.697)	10	25	3	61	4	B	991586
2.70	(2.707)	10	25	3	61	4	B	200123
2.71	(2.717)	10	25	3	61	4	B	954783
2.72	(2.727)	10	25	3	61	4	B	326988
2.73	(2.737)	10	25	3	61	4	B	326989
2.74	(2.747)	10	25	3	61	4	B	969786
2.75	(2.757)	10	25	3	61	4	B	200122
2.76	(2.767)	10	25	3	61	4	B	326990
2.77	(2.777)	10	25	3	61	4	B	326991
2.78	(2.787)	10	25	3	61	4	B	954734
2.79	(2.797)	10	25	3	61	4	B	965219
2.80	(2.807)	10	25	3	61	4	B	200138
2.81	(2.817)	10	25	3	61	4	B	953881
2.82	(2.827)	10	25	3	61	4	B	960888
2.83	(2.837)	10	25	3	61	4	B	326992
2.84	(2.847)	10	25	3	61	4	B	326993
2.85	(2.857)	10	25	3	61	4	B	200132
2.86	(2.867)	10	25	3	61	4	B	326994
2.87	(2.877)	10	25	3	61	4	B	326995
2.88	(2.887)	10	25	3	61	4	B	326996
2.89	(2.897)	10	25	3	61	4	B	953937
2.90	(2.907)	10	25	3	61	4	B	200133
2.91	(2.917)	10	25	3	61	4	B	964090
2.92	(2.927)	10	25	3	61	4	B	66683
2.93	(2.937)	10	25	3	61	4	B	326997
2.94	(2.947)	10	25	3	61	4	B	326998
2.95	(2.957)	10	25	3	61	4	B	200134
2.96	(2.967)	10	25	3	61	4	B	961012
2.97	(2.977)	10	25	3	61	4	B	959664
2.98	(2.987)	10	25	3	70	6	B	321202
2.99	(2.997)	10	25	3	70	6	B	321203
3.00	(3.007)	10	25	3	70	6	B	321204
3.01	(3.018)	10	25	3	70	6	B	321205
3.02	(3.028)	10	25	3	70	6	B	321206
3.03	(3.038)	10	25	3	70	6	B	321207
3.04	(3.048)	10	25	3	70	6	B	321208
3.05	(3.058)	10	25	3	70	6	B	321209
3.06	(3.068)	10	25	3	70	6	B	321210
3.07	(3.078)	10	25	3	70	6	B	321211
3.08	(3.088)	10	25	3	70	6	B	321212
3.09	(3.098)	10	25	3	70	6	B	321213



POLY 4001 - 4001-TC



P. 64



> Ø 2.98

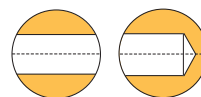

Ref. A

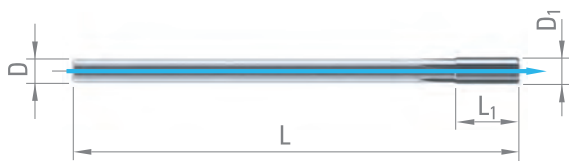

Ref. B

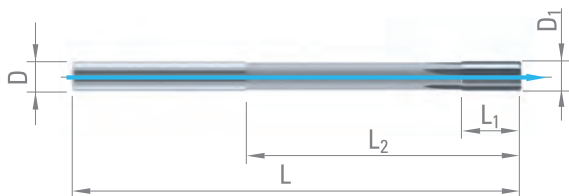

FROM STOCK
EN STOCK
库存

D nom. H7	D ₁ ± 1.5µm	L ₁	L ₂	D _{h5}	L	Z	Ref.	HM
3.10	(3.108)	10	-	3	70	6	A	321214
3.11	(3.118)	10	-	3	70	6	A	321215
3.12	(3.128)	10	-	3	70	6	A	321216
3.13	(3.138)	10	-	3	70	6	A	321217
3.14	(3.148)	10	-	3	70	6	A	321218
3.15	(3.158)	10	-	3	70	6	A	321219
3.16	(3.168)	10	-	3	70	6	A	321220
3.17	(3.178)	10	-	3	70	6	A	321221
3.18	(3.188)	10	-	3	70	6	A	321222
3.19	(3.198)	10	-	3	70	6	A	321223
3.20	(3.208)	10	-	3	70	6	A	321224
3.21	(3.218)	10	-	3	70	6	A	321225
3.22	(3.228)	10	-	3	70	6	A	321226
3.23	(3.238)	10	-	3	70	6	A	321227
3.24	(3.248)	10	-	3	70	6	A	321228
3.25	(3.258)	10	-	3	70	6	A	321229
3.26	(3.268)	10	-	3	70	6	A	321230
3.27	(3.278)	10	-	3	70	6	A	321231
3.28	(3.288)	10	-	3	70	6	A	321232
3.29	(3.298)	10	-	3	70	6	A	321233
3.30	(3.308)	10	-	3	70	6	A	321234
3.31	(3.318)	10	-	3	70	6	A	321235
3.32	(3.328)	10	-	3	70	6	A	321236
3.33	(3.338)	10	-	3	70	6	A	321237
3.34	(3.348)	10	-	3	70	6	A	321238
3.35	(3.358)	10	-	3	70	6	A	321239
3.36	(3.368)	10	-	3	70	6	A	321240
3.37	(3.378)	10	-	3	70	6	A	321241
3.38	(3.388)	10	-	3	70	6	A	321242
3.39	(3.398)	10	-	3	70	6	A	321243
3.40	(3.408)	10	-	3	70	6	A	321244
3.41	(3.418)	10	-	3	70	6	A	321245
3.42	(3.428)	10	-	3	70	6	A	321246
3.43	(3.438)	10	-	3	70	6	A	321247
3.44	(3.448)	10	-	3	70	6	A	321248
3.45	(3.458)	10	-	3	70	6	A	321249
3.46	(3.468)	10	-	3	70	6	A	321250
3.47	(3.478)	10	-	3	70	6	A	321251
3.48	(3.488)	10	-	3	70	6	A	321252
3.49	(3.498)	10	-	3	70	6	A	321253
3.50	(3.508)	10	-	3	70	6	A	321254
3.51	(3.518)	10	-	3	70	6	A	321255
3.52	(3.528)	10	-	3	70	6	A	321256
3.53	(3.538)	10	-	3	70	6	A	321257
3.54	(3.548)	10	-	3	70	6	A	321258
3.55	(3.558)	10	-	3	70	6	A	321259
3.56	(3.568)	10	-	3	70	6	A	321260

D nom. H7	D ₁ ± 1.5µm	L ₁	L ₂	D _{h5}	L	Z	Ref.	HM
3.57	(3.578)	10	-	3	70	6	A	321261
3.58	(3.588)	10	-	3	70	6	A	321262
3.59	(3.598)	10	-	3	70	6	A	321263
3.60	(3.608)	10	-	3	70	6	A	321264
3.61	(3.618)	10	-	3	70	6	A	321265
3.62	(3.628)	10	-	3	70	6	A	321266
3.63	(3.638)	10	-	3	70	6	A	321267
3.64	(3.648)	10	-	3	70	6	A	321268
3.65	(3.658)	10	-	3	70	6	A	321269
3.66	(3.668)	10	-	3	70	6	A	321270
3.67	(3.678)	10	-	3	70	6	A	321271
3.68	(3.688)	10	-	3	70	6	A	321272
3.69	(3.698)	10	-	3	70	6	A	321273
3.70	(3.708)	10	-	3	70	6	A	321274
3.71	(3.718)	10	-	3	70	6	A	321275
3.72	(3.728)	10	-	3	70	6	A	321276
3.73	(3.738)	10	-	3	70	6	A	321277
3.74	(3.748)	10	-	3	70	6	A	321278
3.75	(3.758)	10	-	3	70	6	A	321279
3.76	(3.768)	10	-	3	70	6	A	321280
3.77	(3.778)	10	-	3	70	6	A	321281
3.78	(3.788)	10	-	3	70	6	A	321282
3.79	(3.798)	10	-	3	70	6	A	321283
3.80	(3.808)	10	-	3	70	6	A	321284
3.81	(3.818)	10	-	3	70	6	A	321285
3.82	(3.828)	10	-	3	70	6	A	321286
3.83	(3.838)	10	-	3	70	6	A	321287
3.84	(3.848)	10	-	3	70	6	A	321288
3.85	(3.858)	10	-	3	70	6	A	321289
3.86	(3.868)	10	-	3	70	6	A	321290
3.87	(3.878)	10	-	3	70	6	A	321291
3.88	(3.888)	10	-	3	70	6	A	321292
3.89	(3.898)	10	-	3	70	6	A	321293
3.90	(3.908)	10	-	3	70	6	A	321294
3.91	(3.918)	10	-	3	70	6	A	321295
3.92	(3.928)	10	-	3	70	6	A	321296
3.93	(3.938)	10	-	3	70	6	A	321297
3.94	(3.948)	10	-	3	70	6	A	321298
3.95	(3.958)	10	-	3	70	6	A	321299
3.96	(3.968)	10	-	3	70	6	A	321300
3.97	(3.978)	10	-	3	70	6	A	321301
3.98	(3.988)	10	-	3	70	6	A	321302
3.99	(3.998)	10	-	3	70	6	A	321303
4.00	(4.008)	10	-	3	70	6	A	321304
4.01	(4.018)	10	-	3	70	6	A	321305
4.02	(4.028)	10	-	3	70	6	A	321306
4.03	(4.038)	10	-	3	70	6	A	321307



POLY 4001 - 4001-TC



P. 64

> Ø 2.98

FROM STOCK
EN STOCK
库存

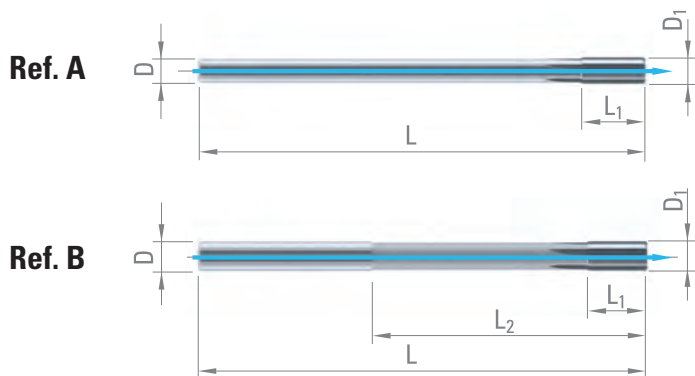

D nom. H7	D ₁ ± 1.5µm	L ₁	L ₂	D _{h5}	L	Z	Ref.	HM
4.04	(4.048)	10	-	3	70	6	A	321308
4.05	(4.058)	10	-	3	70	6	A	321309
4.06	(4.068)	10	-	3	70	6	A	321310
4.07	(4.078)	10	-	3	70	6	A	321311
4.08	(4.088)	10	-	3	70	6	A	321312
4.09	(4.098)	10	-	3	70	6	A	321313
4.10	(4.108)	12	-	4	80	6	A	321314
4.11	(4.118)	12	-	4	80	6	A	321315
4.12	(4.128)	12	-	4	80	6	A	321316
4.13	(4.138)	12	-	4	80	6	A	321317
4.14	(4.148)	12	-	4	80	6	A	321318
4.15	(4.158)	12	-	4	80	6	A	321319
4.16	(4.168)	12	-	4	80	6	A	321320
4.17	(4.178)	12	-	4	80	6	A	321321
4.18	(4.188)	12	-	4	80	6	A	321322
4.19	(4.198)	12	-	4	80	6	A	321323
4.20	(4.208)	12	-	4	80	6	A	321324
4.21	(4.218)	12	-	4	80	6	A	321325
4.22	(4.228)	12	-	4	80	6	A	321326
4.23	(4.238)	12	-	4	80	6	A	321327
4.24	(4.248)	12	-	4	80	6	A	321328
4.25	(4.258)	12	-	4	80	6	A	321329
4.26	(4.268)	12	-	4	80	6	A	321330
4.27	(4.278)	12	-	4	80	6	A	321331
4.28	(4.288)	12	-	4	80	6	A	321332
4.29	(4.298)	12	-	4	80	6	A	321333
4.30	(4.308)	12	-	4	80	6	A	321334
4.31	(4.318)	12	-	4	80	6	A	321335
4.32	(4.328)	12	-	4	80	6	A	321336
4.33	(4.338)	12	-	4	80	6	A	321337
4.34	(4.348)	12	-	4	80	6	A	321338
4.35	(4.358)	12	-	4	80	6	A	321339
4.36	(4.368)	12	-	4	80	6	A	321340
4.37	(4.378)	12	-	4	80	6	A	321341
4.38	(4.388)	12	-	4	80	6	A	321342
4.39	(4.398)	12	-	4	80	6	A	321343
4.40	(4.408)	12	-	4	80	6	A	321344
4.41	(4.418)	12	-	4	80	6	A	321345
4.42	(4.428)	12	-	4	80	6	A	321346
4.43	(4.438)	12	-	4	80	6	A	321347
4.44	(4.448)	12	-	4	80	6	A	321348
4.45	(4.458)	12	-	4	80	6	A	321349
4.46	(4.468)	12	-	4	80	6	A	321350
4.47	(4.478)	12	-	4	80	6	A	321351
4.48	(4.488)	12	-	4	80	6	A	321352
4.49	(4.498)	12	-	4	80	6	A	321353
4.50	(4.508)	12	-	4	80	6	A	321354

D nom. H7	D ₁ ± 1.5µm	L ₁	L ₂	D _{h5}	L	Z	Ref.	HM
4.51	(4.518)	12	-	4	80	6	A	321355
4.52	(4.528)	12	-	4	80	6	A	321356
4.53	(4.538)	12	-	4	80	6	A	321357
4.54	(4.548)	12	-	4	80	6	A	321358
4.55	(4.558)	12	-	4	80	6	A	321359
4.56	(4.568)	12	-	4	80	6	A	321360
4.57	(4.578)	12	-	4	80	6	A	321361
4.58	(4.588)	12	-	4	80	6	A	321362
4.59	(4.598)	12	-	4	80	6	A	321363
4.60	(4.608)	12	-	4	80	6	A	321364
4.61	(4.618)	12	-	4	80	6	A	321365
4.62	(4.628)	12	-	4	80	6	A	321366
4.63	(4.638)	12	-	4	80	6	A	321367
4.64	(4.648)	12	-	4	80	6	A	321368
4.65	(4.658)	12	-	4	80	6	A	321369
4.66	(4.668)	12	-	4	80	6	A	321370
4.67	(4.678)	12	-	4	80	6	A	321371
4.68	(4.688)	12	-	4	80	6	A	321372
4.69	(4.698)	12	-	4	80	6	A	321373
4.70	(4.708)	12	-	4	80	6	A	321374
4.71	(4.718)	12	-	4	80	6	A	321375
4.72	(4.728)	12	-	4	80	6	A	321376
4.73	(4.738)	12	-	4	80	6	A	321377
4.74	(4.748)	12	-	4	80	6	A	321378
4.75	(4.758)	12	-	4	80	6	A	321379
4.76	(4.768)	12	-	4	80	6	A	321380
4.77	(4.778)	12	-	4	80	6	A	321381
4.78	(4.788)	12	-	4	80	6	A	321382
4.79	(4.798)	12	-	4	80	6	A	321383
4.80	(4.808)	12	-	4	80	6	A	321384
4.81	(4.818)	12	-	4	80	6	A	321385
4.82	(4.828)	12	-	4	80	6	A	321386
4.83	(4.838)	12	-	4	80	6	A	321387
4.84	(4.848)	12	-	4	80	6	A	321388
4.85	(4.858)	12	-	4	80	6	A	321389
4.86	(4.868)	12	-	4	80	6	A	321390
4.87	(4.878)	12	-	4	80	6	A	321391
4.88	(4.888)	12	-	4	80	6	A	321392
4.89	(4.898)	12	-	4	80	6	A	321393
4.90	(4.908)	12	-	4	80	6	A	321394
4.91	(4.918)	12	-	4	80	6	A	321395
4.92	(4.928)	12	-	4	80	6	A	321396
4.93	(4.938)	12	-	4	80	6	A	321397
4.94	(4.948)	12	-	4	80	6	A	321398
4.95	(4.958)	12	-	4	80	6	A	321399
4.96	(4.968)	12	-	4	80	6	A	321400
4.97	(4.978)	12	-	4	80	6	A	321401



POLY 4001 - 4001-TC



P. 64



> Ø 2.98

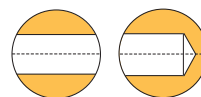

Ref. A

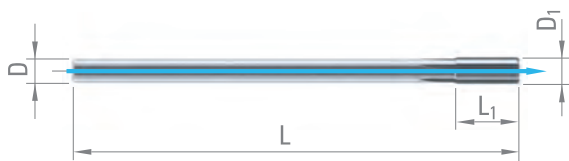

Ref. B

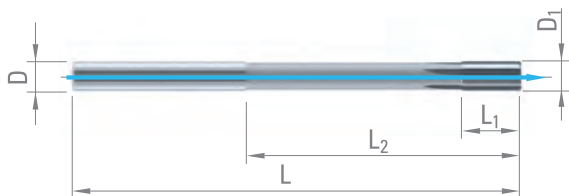

FROM STOCK
EN STOCK
库存

D nom. H7	D ₁ ± 1.5µm	L ₁	L ₂	D _{h5}	L	Z	Ref.	HM
4.98 (4.988)	12	-	4	80	6	A	321402	
4.99 (4.998)	12	-	4	80	6	A	321403	
5.00 (5.008)	12	-	4	80	6	A	321404	
5.01 (5.018)	12	-	4	80	6	A	321405	
5.02 (5.028)	12	-	4	80	6	A	321406	
5.03 (5.038)	12	-	4	80	6	A	321407	
5.04 (5.048)	12	-	4	80	6	A	321408	
5.05 (5.058)	12	-	4	80	6	A	321409	
5.06 (5.068)	12	-	4	80	6	A	321410	
5.07 (5.078)	12	-	4	80	6	A	321411	
5.08 (5.088)	12	-	4	80	6	A	321412	
5.09 (5.098)	12	-	4	80	6	A	321413	
5.10 (5.108)	12	-	4	80	6	A	321414	
5.11 (5.118)	12	-	4	80	6	A	321415	
5.12 (5.128)	12	-	4	80	6	A	321416	
5.13 (5.138)	12	-	4	80	6	A	321417	
5.14 (5.148)	12	-	4	80	6	A	321418	
5.15 (5.158)	12	-	4	80	6	A	321419	
5.16 (5.168)	12	-	4	80	6	A	321420	
5.17 (5.178)	12	-	4	80	6	A	321421	
5.18 (5.188)	12	-	4	80	6	A	321422	
5.19 (5.198)	12	-	4	80	6	A	321423	
5.20 (5.208)	12	-	4	80	6	A	321424	
5.21 (5.218)	12	-	4	80	6	A	321425	
5.22 (5.228)	12	-	4	80	6	A	321426	
5.23 (5.238)	12	-	4	80	6	A	321427	
5.24 (5.248)	12	-	4	80	6	A	321428	
5.25 (5.258)	12	-	4	80	6	A	321429	
5.26 (5.268)	12	-	4	80	6	A	321430	
5.27 (5.278)	12	-	4	80	6	A	321431	
5.28 (5.288)	12	-	4	80	6	A	321432	
5.29 (5.298)	12	-	4	80	6	A	321433	
5.30 (5.308)	12	-	4	80	6	A	321434	
5.31 (5.318)	12	-	4	80	6	A	321435	
5.32 (5.328)	12	-	4	80	6	A	321436	
5.33 (5.338)	12	-	4	80	6	A	321437	
5.34 (5.348)	12	-	4	80	6	A	321438	
5.35 (5.358)	12	-	4	80	6	A	321439	
5.36 (5.368)	12	-	4	80	6	A	321440	
5.37 (5.378)	12	-	4	80	6	A	321441	
5.38 (5.388)	12	-	4	80	6	A	321442	
5.39 (5.398)	12	-	4	80	6	A	321443	
5.40 (5.408)	12	-	4	80	6	A	321444	
5.41 (5.418)	12	-	4	80	6	A	321445	
5.42 (5.428)	12	-	4	80	6	A	321446	
5.43 (5.438)	12	-	4	80	6	A	321447	
5.44 (5.448)	12	-	4	80	6	A	321448	

D nom. H7	D ₁ ± 1.5µm	L ₁	L ₂	D _{h5}	L	Z	Ref.	HM
5.45 (5.458)	12	-	4	80	6	A	321449	
5.46 (5.468)	12	-	4	80	6	A	321450	
5.47 (5.478)	12	-	4	80	6	A	321451	
5.48 (5.488)	12	-	4	80	6	A	321452	
5.49 (5.498)	12	-	4	80	6	A	321453	
5.50 (5.508)	12	-	4	80	6	A	321454	
5.51 (5.518)	12	-	4	80	6	A	321455	
5.52 (5.528)	12	-	4	80	6	A	321456	
5.53 (5.538)	12	-	4	80	6	A	321457	
5.54 (5.548)	12	-	4	80	6	A	321458	
5.55 (5.558)	12	-	4	80	6	A	321459	
5.56 (5.568)	12	-	4	80	6	A	321460	
5.57 (5.578)	12	-	4	80	6	A	321461	
5.58 (5.588)	12	-	4	80	6	A	321462	
5.59 (5.598)	12	-	4	80	6	A	321463	
5.60 (5.608)	12	-	4	80	6	A	321464	
5.61 (5.618)	12	-	4	80	6	A	321465	
5.62 (5.628)	12	-	4	80	6	A	321466	
5.63 (5.638)	12	-	4	80	6	A	321467	
5.64 (5.648)	12	-	4	80	6	A	321468	
5.65 (5.658)	12	-	4	80	6	A	321469	
5.66 (5.668)	12	-	4	80	6	A	321470	
5.67 (5.678)	12	-	4	80	6	A	321471	
5.68 (5.688)	12	-	4	80	6	A	321472	
5.69 (5.698)	12	-	4	80	6	A	321473	
5.70 (5.708)	12	-	4	80	6	A	321474	
5.71 (5.718)	12	-	4	80	6	A	321475	
5.72 (5.728)	12	-	4	80	6	A	321476	
5.73 (5.738)	12	-	4	80	6	A	321477	
5.74 (5.748)	12	-	4	80	6	A	321478	
5.75 (5.758)	12	-	4	80	6	A	321479	
5.76 (5.768)	12	-	4	80	6	A	321480	
5.77 (5.778)	12	-	4	80	6	A	321481	
5.78 (5.788)	12	-	4	80	6	A	321482	
5.79 (5.798)	12	-	4	80	6	A	321483	
5.80 (5.808)	12	-	4	80	6	A	321484	
5.81 (5.818)	12	-	4	80	6	A	321485	
5.82 (5.828)	12	-	4	80	6	A	321486	
5.83 (5.838)	12	-	4	80	6	A	321487	
5.84 (5.848)	12	-	4	80	6	A	321488	
5.85 (5.858)	12	-	4	80	6	A	321489	
5.86 (5.868)	12	-	4	80	6	A	321490	
5.87 (5.878)	12	-	4	80	6	A	321491	
5.88 (5.888)	12	-	4	80	6	A	321492	
5.89 (5.898)	12	-	4	80	6	A	321493	
5.90 (5.908)	12	-	4	80	6	A	321494	
5.91 (5.918)	12	-	4	80	6	A	321495	



POLY 4001 - 4001-TC

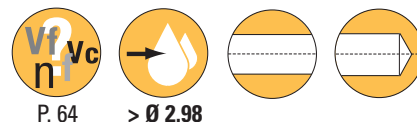

P. 64

> Ø 2.98

FROM STOCK
EN STOCK
库存

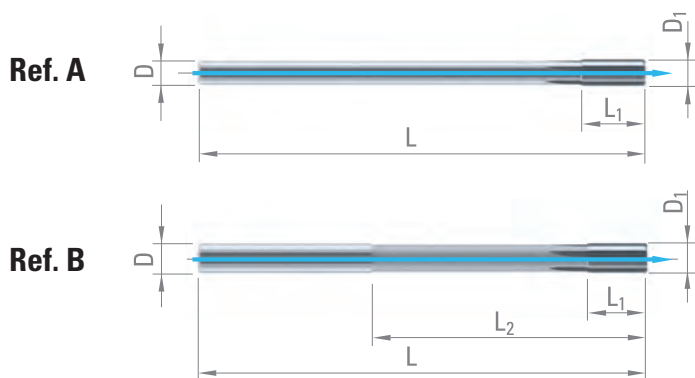

D nom. H7	D ₁ ± 1.5µm	L ₁	L ₂	D _{h5}	L	Z	Ref.	HM
5.92	(5.928)	12	-	4	80	6	A	321496
5.93	(5.938)	12	-	4	80	6	A	321497
5.94	(5.948)	12	-	4	80	6	A	321498
5.95	(5.958)	12	-	4	80	6	A	321499
5.96	(5.968)	12	-	4	80	6	A	321500
5.97	(5.978)	12	-	4	80	6	A	321501
5.98	(5.988)	12	-	4	80	6	A	321502
5.99	(5.998)	12	-	4	80	6	A	321503
6.00	(6.008)	12	-	4	80	6	A	321504
6.01	(6.020)	12	-	4	80	6	A	321505
6.02	(6.030)	12	-	4	80	6	A	321506
6.03	(6.040)	12	-	4	80	6	A	321507
6.04	(6.050)	12	-	4	80	6	A	321508
6.05	(6.060)	12	-	4	80	6	A	321509
6.06	(6.070)	12	-	4	80	6	A	321510
6.07	(6.080)	12	-	4	80	6	A	321511
6.08	(6.090)	12	-	4	80	6	A	321512
6.09	(6.100)	12	-	4	80	6	A	321513
6.10	(6.110)	12	-	4	80	6	A	321514
6.11	(6.120)	12	-	4	80	6	A	321515
6.12	(6.130)	12	-	4	80	6	A	321516
6.13	(6.140)	12	-	4	80	6	A	321517
6.14	(6.150)	12	-	4	80	6	A	321518
6.15	(6.160)	12	-	4	80	6	A	321519
6.16	(6.170)	12	-	4	80	6	A	321520
6.17	(6.180)	12	-	4	80	6	A	321521
6.18	(6.190)	12	-	4	80	6	A	321522
6.19	(6.200)	12	-	4	80	6	A	321523
6.20	(6.210)	16	-	6	101	6	A	341670
6.30	(6.310)	16	-	6	101	6	A	341680
6.35	(6.360)	16	-	6	101	6	A	341685
6.40	(6.410)	16	-	6	101	6	A	341690
6.48	(6.490)	16	-	6	101	6	A	341698
6.49	(6.500)	16	-	6	101	6	A	341699
6.50	(6.510)	16	-	6	101	6	A	341700
6.51	(6.520)	16	-	6	101	6	A	341701
6.52	(6.530)	16	-	6	101	6	A	341702
6.55	(6.560)	16	-	6	101	6	A	341705
6.60	(6.610)	16	-	6	101	6	A	341710
6.70	(6.710)	16	-	6	101	6	A	341720
6.80	(6.810)	16	-	6	101	6	A	341730
6.90	(6.910)	16	-	6	101	6	A	341740
7.00	(7.010)	16	-	6	101	6	A	341750

D nom. H7	D ₁ ± 1.5µm	L ₁	L ₂	D _{h5}	L	Z	Ref.	HM
7.01	(7.020)	16	-	6	101	6	A	341751
7.02	(7.030)	16	-	6	101	6	A	341752
7.10	(7.110)	16	-	6	101	6	A	341760
7.20	(7.210)	16	-	6	101	6	A	341770
7.30	(7.310)	16	-	6	101	6	A	341780
7.40	(7.410)	16	-	6	101	6	A	341790
7.50	(7.510)	16	-	6	101	6	A	341800
7.60	(7.610)	16	-	6	101	6	A	341810
7.70	(7.710)	16	-	6	101	6	A	341820
7.80	(7.810)	16	-	6	101	6	A	341830
7.90	(7.910)	16	-	6	101	6	A	341840
7.98	(7.990)	16	-	6	101	6	A	341848
7.99	(8.000)	16	-	6	101	6	A	341849
8.00	(8.010)	16	-	6	101	6	A	341850
8.01	(8.020)	16	-	6	101	6	A	341851
8.02	(8.030)	16	-	6	101	6	A	341852
8.05	(8.060)	16	-	6	101	6	A	341855
8.10	(8.110)	16	-	6	117	6	A	341860
8.20	(8.210)	16	-	6	117	6	A	341870
8.30	(8.310)	16	-	6	117	6	A	341880
8.40	(8.410)	16	-	6	117	6	A	341890
8.50	(8.510)	16	-	6	117	6	A	341900
8.70	(8.710)	16	-	6	117	6	A	341920
9.00	(9.010)	16	-	6	117	6	A	341950
9.30	(9.310)	16	-	6	117	6	A	341980
9.50	(9.510)	16	-	6	117	6	A	342000
9.70	(9.710)	16	-	6	117	6	A	342020
9.98	(9.990)	16	-	6	117	6	A	342048
9.99	(10.000)	16	-	6	117	6	A	342049
10.00	(10.010)	16	-	6	117	6	A	342050
10.01	(10.020)	16	-	6	117	6	A	342051
10.02	(10.032)	19	87	10	133	6	B	952322
10.04	(10.052)	19	87	10	133	6	B	962649
10.05	(10.062)	19	87	10	133	6	B	962568
10.10	(10.112)	19	87	10	133	6	B	952765
10.40	(10.412)	19	87	10	133	6	B	968160
10.50	(10.512)	19	87	10	133	6	B	952766
10.60	(10.612)	19	87	10	133	6	B	952767
11.00	(11.012)	19	96	12	142	6	B	952768
11.50	(11.512)	19	96	12	142	6	B	952769
11.80	(11.812)	19	96	12	142	6	B	952770
12.00	(12.012)	19	105	12	151	6	B	952771
12.02	(12.032)	19	105	12	151	6	B	952772

All Ø with tolerance ±2µm available through our express-service

Cualquier diámetro disponible sobre demanda con tolerancia ±2µm a través de nuestro servicio rápido

通过我们特殊定制，所有直径尺寸公差可达±2 µm



POLY 4005-TC

SOLID CARBIDE REAMERS, RIGHT-HAND HELIX
 ESCARIADORES DE CARBURO MONOBLOC, HÉLICE A DERECHA
 整体硬质合金铰刀，右手切削

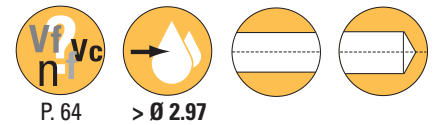

P. 64

> Ø 2.97

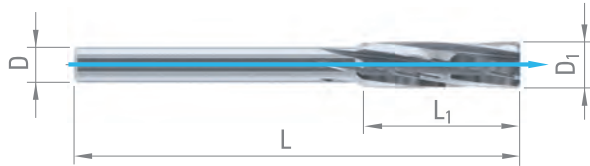

FROM STOCK
 EN STOCK
 库存

D nom. H7	D ₁ ± 1.5µm	L ₁	D _{h5}	L	Z	HM	D nom. H7	D ₁ ± 1.5µm	L ₁	D _{h5}	L	Z	HM
2.97	(2.977)	20	2.5	56	4	969074	3.75	(3.758)	20	3.0	56	4	969430
2.99	(2.997)	20	2.5	56	4	969379	3.78	(3.788)	20	3.0	56	4	969431
3.00	(3.007)	20	2.5	56	4	969382	3.80	(3.808)	20	3.0	56	4	969432
3.01	(3.018)	20	2.5	56	4	969398	3.85	(3.858)	20	3.0	56	4	969433
3.02	(3.028)	20	2.5	56	4	969399	3.90	(3.908)	20	3.0	56	4	969434
3.05	(3.058)	20	2.5	56	4	969400	3.95	(3.958)	20	3.0	56	4	969435
3.08	(3.088)	20	2.5	56	4	969401	4.00	(4.008)	20	3.0	56	4	969436
3.10	(3.108)	20	2.5	56	4	969402	4.04	(4.048)	22	3.5	63	6	993718
3.11	(3.118)	20	2.5	56	4	969403	4.10	(4.108)	22	3.5	63	6	969437
3.15	(3.158)	20	2.5	56	4	969404	4.20	(4.208)	22	3.5	63	6	969438
3.18	(3.188)	20	2.5	56	4	969405	4.30	(4.308)	22	3.5	63	6	969439
3.20	(3.208)	20	2.5	56	4	969406	4.40	(4.408)	22	3.5	63	6	969440
3.21	(3.218)	20	2.5	56	4	969407	4.50	(4.508)	22	4.0	63	6	969441
3.25	(3.258)	20	2.5	56	4	969408	4.60	(4.608)	22	4.0	63	6	969442
3.28	(3.288)	20	2.5	56	4	969409	4.70	(4.708)	22	4.0	63	6	969443
3.30	(3.308)	20	2.5	56	4	969410	4.80	(4.808)	22	4.0	63	6	969444
3.31	(3.318)	20	2.5	56	4	969411	4.90	(4.908)	22	4.0	63	6	969445
3.35	(3.358)	20	2.5	56	4	969412	5.00	(5.008)	22	4.0	63	6	969446
3.38	(3.388)	20	2.5	56	4	969413	5.10	(5.108)	22	4.0	63	6	969447
3.40	(3.408)	20	2.5	56	4	969414	5.20	(5.208)	22	4.0	63	6	969448
3.41	(3.418)	20	2.5	56	4	969415	5.30	(5.308)	22	4.0	63	6	969449
3.45	(3.458)	20	2.5	56	4	969416	5.40	(5.408)	22	4.0	63	6	969450
3.49	(3.498)	20	2.5	56	4	969417	5.50	(5.508)	22	5.0	63	6	969451
3.50	(3.508)	20	3.0	56	4	969418	5.60	(5.608)	22	5.0	63	6	969452
3.51	(3.518)	20	3.0	56	4	969421	5.70	(5.708)	22	5.0	63	6	969453
3.55	(3.558)	20	3.0	56	4	969422	5.80	(5.808)	22	5.0	63	6	969454
3.58	(3.588)	20	3.0	56	4	969423	5.90	(5.908)	22	5.0	63	6	969455
3.60	(3.608)	20	3.0	56	4	969424	6.00	(6.008)	22	5.0	63	6	969456
3.61	(3.618)	20	3.0	56	4	969425	6.10	(6.110)	22	5.0	63	6	969457
3.65	(3.658)	20	3.0	56	4	969426	6.20	(6.210)	22	5.0	63	6	969458
3.68	(3.688)	20	3.0	56	4	969427	6.30	(6.310)	22	5.0	63	6	969459
3.70	(3.708)	20	3.0	56	4	969428	6.40	(6.410)	22	5.0	63	6	969460
3.71	(3.718)	20	3.0	56	4	969429	6.50	(6.510)	22	5.0	63	6	969461

All Ø with tolerance ±2µm available through our express-service
 Cualquier diámetro disponible sobre demanda con tolerancia ±2µm
 a través de nuestro servicio rápido
 通过我们特殊定制，所有直径尺寸公差可达±2 µm

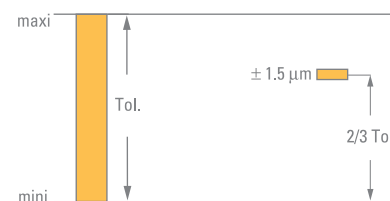

POLY 4007 - 4007-TC

SOLID CARBIDE REAMERS, LEFT-HAND HELIX
 ESCARIADORES DE CARBURO MONOBLOC, HÉLICE A IZQUIERDA
 整体硬质合金铰刀，左手切削



P. 64



> Ø 2.97



FROM STOCK
EN STOCK
库存

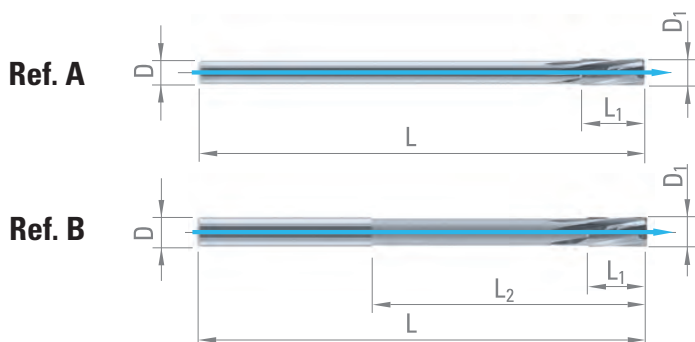

D _{10/+0.003}	L ₁	L ₂	D _{h5}	L	Z	Ref.	HM
0.37	3	5	3	38	3	B	983079
0.38	3	5	3	38	3	B	326999
0.39	3	5	3	38	3	B	969543
0.40	3	5	3	38	3	B	200716
0.41	3	5	3	38	3	B	963823
0.42	3	5	3	38	3	B	200717
0.43	3	5	3	38	3	B	327000
0.44	3	5	3	38	3	B	200718
0.45	3	5	3	38	3	B	965207
0.46	3	5	3	38	3	B	200719
0.47	3	5	3	38	3	B	327001
0.48	3	5	3	38	3	B	200720
0.49	3	5	3	38	3	B	963716
0.50	3	5	3	38	3	B	200746
0.51	4	6	3	38	3	B	200745
0.52	4	6	3	38	3	B	200738
0.53	4	6	3	38	3	B	200742
0.54	4	6	3	38	3	B	200743
0.55	4	6	3	38	3	B	200739
0.56	4	6	3	38	3	B	968834
0.57	4	6	3	38	3	B	973253
0.58	4	6	3	38	3	B	200741
0.59	4	6	3	38	3	B	200744
0.60	4	6	3	38	3	B	200740
0.61	4	7	3	38	3	B	964652
0.62	4	7	3	38	3	B	200750
0.63	4	7	3	38	3	B	327002
0.64	4	7	3	38	3	B	200755
0.65	4	7	3	38	3	B	200748
0.66	4	7	3	38	3	B	200752
0.67	4	7	3	38	3	B	200753
0.68	4	7	3	38	3	B	200751
0.69	4	7	3	38	3	B	200754
0.70	4	7	3	38	3	B	200749
0.71	4	8	3	38	3	B	965167
0.72	4	8	3	38	3	B	200758
0.73	4	8	3	38	3	B	327003
0.74	4	8	3	38	3	B	200762
0.75	4	8	3	38	3	B	200756
0.76	4	8	3	38	3	B	327004
0.77	4	8	3	38	3	B	200760
0.78	4	8	3	38	3	B	200759
0.79	4	8	3	38	3	B	200761
0.80	4	8	3	38	3	B	200757
0.81	5	9	3	38	3	B	965168

D _{10/+0.003}	L ₁	L ₂	D _{h5}	L	Z	Ref.	HM
0.82	5	9	3	38	3	B	200765
0.83	5	9	3	38	3	B	200769
0.84	5	9	3	38	3	B	200768
0.85	5	9	3	38	3	B	200763
0.86	5	9	3	38	3	B	200770
0.87	5	9	3	38	3	B	200771
0.88	5	9	3	38	3	B	200766
0.89	5	9	3	38	3	B	200767
0.90	5	9	3	38	3	B	200764
0.91	5	10	3	38	3	B	200733
0.92	5	10	3	38	3	B	200729
0.93	5	10	3	38	3	B	327005
0.94	5	10	3	38	3	B	327006
0.95	5	10	3	38	3	B	200728
0.96	5	10	3	38	3	B	200730
0.97	5	10	3	38	3	B	200731
0.98	5	10	3	38	3	B	200726
0.99	5	10	3	38	3	B	200727
1.00	5	10	3	38	3	B	200732
1.01	5	11	3	38	3	B	200715
1.02	5	11	3	38	3	B	200772
1.03	5	11	3	38	3	B	967191
1.04	5	11	3	38	3	B	327007
1.05	5	11	3	38	3	B	200773
1.06	5	11	3	38	3	B	327008
1.07	5	11	3	38	3	B	327009
1.08	5	11	3	38	3	B	200774
1.09	5	11	3	38	3	B	965169
1.10	5	11	3	38	3	B	200777
1.11	5	12	3	38	3	B	327010
1.12	5	12	3	38	3	B	327011
1.13	5	12	3	38	3	B	327012
1.14	5	12	3	38	3	B	327013
1.15	5	12	3	38	3	B	200775
1.16	5	12	3	38	3	B	327014
1.17	5	12	3	38	3	B	327015
1.18	5	12	3	38	3	B	63965
1.19	5	12	3	38	3	B	327016
1.20	5	12	3	38	3	B	200776
1.21	6	13	3	38	3	B	965171
1.22	6	13	3	38	3	B	327017
1.23	6	13	3	38	3	B	327018
1.24	6	13	3	38	3	B	327019
1.25	6	13	3	38	3	B	200778
1.26	6	13	3	38	3	B	963588

All Ø with tolerance ±2µm available through our express-service

Cualquier diámetro disponible sobre demanda con tolerancia ±2mm a través nuestro servicio rápido

通过我们特殊定制，所有直径尺寸公差可达±2 µm





P. 64



> Ø 2.97



Ref. A

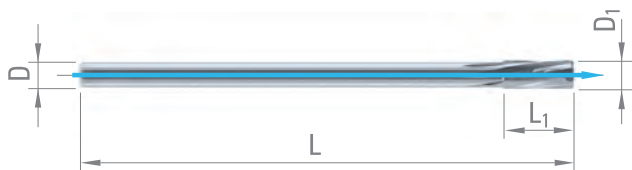

Ref. B

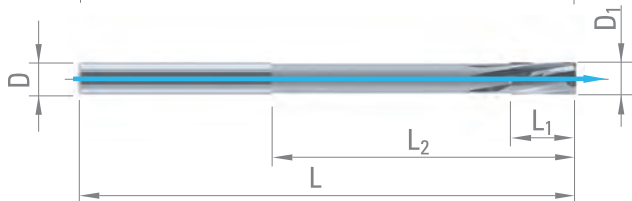

FROM STOCK
EN STOCK
库存

D _{10/+0.003}	L ₁	L ₂	D _{h5}	L	Z	Ref.	HM
1.27	6	13	3	38	3	B	972014
1.28	6	13	3	38	3	B	200780
1.29	6	13	3	38	3	B	327020
1.30	6	13	3	38	3	B	200779
1.31	6	13	3	38	3	B	967299
1.32	6	13	3	38	3	B	327021
1.33	6	13	3	38	3	B	327022
1.34	6	13	3	38	3	B	973390
1.35	6	13	3	38	3	B	200734
1.36	6	13	3	38	3	B	327023
1.37	6	13	3	38	3	B	327024
1.38	6	13	3	38	3	B	327025
1.39	6	13	3	38	3	B	327026
1.40	6	13	3	38	3	B	200735
1.41	7	15	3	38	3	B	327027
1.42	7	15	3	38	3	B	327028
1.43	7	15	3	38	3	B	327029
1.44	7	15	3	38	3	B	327030
1.45	7	15	3	38	3	B	200783
1.46	7	15	3	38	3	B	327031
1.47	7	15	3	38	3	B	327032
1.48	7	15	3	38	3	B	200781
1.49	7	15	3	38	3	B	200782
1.50	7	15	3	38	3	B	200784
1.51	7	15	3	50	3	B	200787
1.52	7	15	3	50	3	B	200788
1.53	7	15	3	50	3	B	327033
1.54	7	15	3	50	3	B	327034
1.55	7	15	3	50	3	B	200692
1.56	7	15	3	50	3	B	976176
1.57	7	15	3	50	3	B	964655
1.58	7	15	3	50	3	B	63966
1.59	7	15	3	50	3	B	965174
1.60	7	15	3	50	3	B	200794
1.61	7	16	3	50	3	B	965175
1.62	7	16	3	50	3	B	327035
1.63	7	16	3	50	3	B	327036
1.64	7	16	3	50	3	B	327037
1.65	7	16	3	50	3	B	200691
1.66	7	16	3	50	3	B	327038
1.67	7	16	3	50	3	B	327039
1.68	7	16	3	50	3	B	327040
1.69	7	16	3	50	3	B	965209
1.70	7	16	3	50	3	B	200693
1.71	7	17	3	50	3	B	327041
1.72	7	17	3	50	3	B	327042
1.73	7	17	3	50	3	B	327043

D _{10/+0.003}	L ₁	L ₂	D _{h5}	L	Z	Ref.	HM
1.74	7	17	3	50	3	B	327044
1.75	7	17	3	50	3	B	200694
1.76	7	17	3	50	3	B	327045
1.77	7	17	3	50	3	B	327046
1.78	7	17	3	50	3	B	327047
1.79	7	17	3	50	3	B	200713
1.80	7	17	3	50	3	B	200795
1.81	8	17	3	50	3	B	327048
1.82	8	17	3	50	3	B	327049
1.83	8	17	3	50	3	B	971471
1.84	8	17	3	50	3	B	327050
1.85	8	17	3	50	3	B	200796
1.86	8	17	3	50	3	B	972720
1.87	8	17	3	50	3	B	964530
1.88	8	17	3	50	3	B	971918
1.89	8	17	3	50	3	B	200704
1.90	8	17	3	50	3	B	20079
1.91	8	18	3	50	3	B	965177
1.92	8	18	3	50	3	B	327051
1.93	8	18	3	50	3	B	327052
1.94	8	18	3	50	3	B	327053
1.95	8	18	3	50	3	B	200682
1.96	8	18	3	50	3	B	200712
1.97	8	18	3	50	3	B	200789
1.98	8	18	3	50	3	B	200790
1.99	8	18	3	50	3	B	200791
2.00	8	18	3	50	3	B	200785
2.01	8	18	3	50	3	B	200792
2.02	8	18	3	50	3	B	200793
2.03	8	18	3	50	3	B	327054
2.04	8	18	3	50	3	B	200714
2.05	8	18	3	50	3	B	200688
2.06	8	18	3	50	3	B	327055
2.07	8	18	3	50	3	B	327056
2.08	8	18	3	50	3	B	327057
2.09	8	18	3	50	3	B	968093
2.10	8	18	3	50	3	B	200711
2.11	8	18	3	50	3	B	327058
2.12	8	18	3	50	3	B	968735
2.13	8	18	3	50	3	B	327059
2.14	8	18	3	50	3	B	968737
2.15	8	18	3	50	3	B	200687
2.16	8	18	3	50	3	B	327060
2.17	8	18	3	50	3	B	327061
2.18	8	18	3	50	3	B	327062
2.19	8	18	3	50	3	B	967119
2.20	8	18	3	50	3	B	200706



POLY 4007 - 4007-TC



P. 64



> Ø 2.97



Ref. A



Ref. B

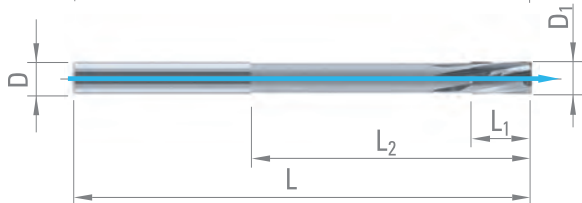

FROM STOCK
EN STOCK
库存

D _{10/+0.003}	L ₁	L ₂	D _{h5}	L	Z	Ref.	HM
2.21	8	18	3	50	3	B	327063
2.22	8	18	3	50	3	B	327064
2.23	8	18	3	50	3	B	327065
2.24	8	18	3	50	3	B	327066
2.25	8	18	3	50	3	B	200686
2.26	8	18	3	50	3	B	327067
2.27	8	18	3	50	3	B	327068
2.28	8	18	3	50	3	B	327069
2.29	8	18	3	50	3	B	327070
2.30	8	18	3	50	3	B	200698
2.31	10	20	3	50	3	B	327071
2.32	10	20	3	50	3	B	200702
2.33	10	20	3	50	3	B	327072
2.34	10	20	3	50	3	B	327073
2.35	10	20	3	50	3	B	200697
2.36	10	20	3	50	3	B	327074
2.37	10	20	3	50	3	B	327075
2.38	10	20	3	50	3	B	327076
2.39	10	20	3	50	3	B	327077
2.40	10	20	3	50	3	B	200696
2.41	10	20	3	50	3	B	972007
2.42	10	20	3	50	3	B	327078
2.43	10	20	3	50	3	B	327079
2.44	10	20	3	50	3	B	327080
2.45	10	20	3	50	3	B	200695
2.46	10	20	3	50	3	B	327081
2.47	10	20	3	50	3	B	327082
2.48	10	20	3	50	3	B	200707
2.49	10	20	3	50	3	B	200708
2.50	10	20	3	50	3	B	200786
2.51	10	20	3	61	4	B	200709
2.52	10	20	3	61	4	B	200710
2.53	10	20	3	61	4	B	327083
2.54	10	20	3	61	4	B	327084
2.55	10	20	3	61	4	B	200685
2.56	10	20	3	61	4	B	327085
2.57	10	20	3	61	4	B	327086
2.58	10	20	3	61	4	B	327087
2.59	10	20	3	61	4	B	327088
2.60	10	20	3	61	4	B	200684
2.61	10	25	3	61	4	B	327089
2.62	10	25	3	61	4	B	327090
2.63	10	25	3	61	4	B	327091
2.64	10	25	3	61	4	B	327092
2.65	10	25	3	61	4	B	200683
2.66	10	25	3	61	4	B	327093
2.67	10	25	3	61	4	B	200703

D _{10/+0.003}	L ₁	L ₂	D _{h5}	L	Z	Ref.	HM
2.68	10	25	3	61	4	B	327094
2.69	10	25	3	61	4	B	327095
2.70	10	25	3	61	4	B	200690
2.71	10	25	3	61	4	B	327096
2.72	10	25	3	61	4	B	327097
2.73	10	25	3	61	4	B	327098
2.74	10	25	3	61	4	B	327099
2.75	10	25	3	61	4	B	200689
2.76	10	25	3	61	4	B	327100
2.77	10	25	3	61	4	B	327101
2.78	10	25	3	61	4	B	327102
2.79	10	25	3	61	4	B	327103
2.80	10	25	3	61	4	B	200705
2.81	10	25	3	61	4	B	327104
2.82	10	25	3	61	4	B	327105
2.83	10	25	3	61	4	B	327106
2.84	10	25	3	61	4	B	327107
2.85	10	25	3	61	4	B	200699
2.86	10	25	3	61	4	B	327108
2.87	10	25	3	61	4	B	327109
2.88	10	25	3	61	4	B	327110
2.89	10	25	3	61	4	B	327111
2.90	10	25	3	61	4	B	200700
2.91	10	25	3	61	4	B	327112
2.92	10	25	3	61	4	B	327113
2.93	10	25	3	61	4	B	327114
2.94	10	25	3	61	4	B	327115
2.95	10	25	3	61	4	B	200701
2.96	10	25	3	61	4	B	327116
2.97	10	25	3	61	4	B	200747
2.98	10	25	3	70	6	B	321524
2.99	10	25	3	70	6	B	321525
3.00	10	25	3	70	6	B	321526
3.01	10	25	3	70	6	B	321527
3.02	10	25	3	70	6	B	321528
3.03	10	25	3	70	6	B	321529
3.04	10	25	3	70	6	B	321530
3.05	10	25	3	70	6	B	321531
3.06	10	25	3	70	6	B	321532
3.07	10	25	3	70	6	B	321533
3.08	10	25	3	70	6	B	321534
3.09	10	25	3	70	6	B	321535
3.10	10	-	3	70	6	A	321536
3.11	10	-	3	70	6	A	321537
3.12	10	-	3	70	6	A	321538
3.13	10	-	3	70	6	A	321539
3.14	10	-	3	70	6	A	321540



POLY 4007 - 4007-TC



P. 64



> Ø 2.97



Ref. A



Ref. B

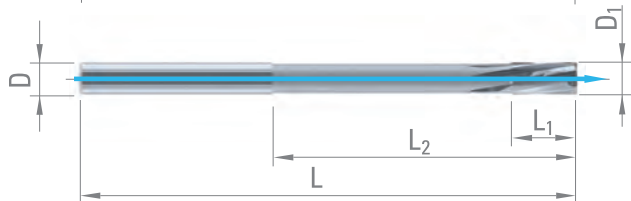

FROM STOCK
EN STOCK
库存

$D_{10/+0.003}$	L_1	L_2	D_{h5}	L	Z	Ref.	HM
3.15	10	-	3	70	6	A	321541
3.16	10	-	3	70	6	A	321542
3.17	10	-	3	70	6	A	321543
3.18	10	-	3	70	6	A	321544
3.19	10	-	3	70	6	A	321545
3.20	10	-	3	70	6	A	321546
3.21	10	-	3	70	6	A	321547
3.22	10	-	3	70	6	A	321548
3.23	10	-	3	70	6	A	321549
3.24	10	-	3	70	6	A	321550
3.25	10	-	3	70	6	A	321551
3.26	10	-	3	70	6	A	321552
3.27	10	-	3	70	6	A	321553
3.28	10	-	3	70	6	A	321554
3.29	10	-	3	70	6	A	321555
3.30	10	-	3	70	6	A	321556
3.31	10	-	3	70	6	A	321557
3.32	10	-	3	70	6	A	321558
3.33	10	-	3	70	6	A	321559
3.34	10	-	3	70	6	A	321560
3.35	10	-	3	70	6	A	321561
3.36	10	-	3	70	6	A	321562
3.37	10	-	3	70	6	A	321563
3.38	10	-	3	70	6	A	321564
3.39	10	-	3	70	6	A	321565
3.40	10	-	3	70	6	A	321566
3.41	10	-	3	70	6	A	321567
3.42	10	-	3	70	6	A	321568
3.43	10	-	3	70	6	A	321569
3.44	10	-	3	70	6	A	321570
3.45	10	-	3	70	6	A	321571
3.46	10	-	3	70	6	A	321572
3.47	10	-	3	70	6	A	321573
3.48	10	-	3	70	6	A	321574
3.49	10	-	3	70	6	A	321575
3.50	10	-	3	70	6	A	321576
3.51	10	-	3	70	6	A	321577
3.52	10	-	3	70	6	A	321578
3.53	10	-	3	70	6	A	321579
3.54	10	-	3	70	6	A	321580
3.55	10	-	3	70	6	A	321581
3.56	10	-	3	70	6	A	321582
3.57	10	-	3	70	6	A	321583
3.58	10	-	3	70	6	A	321584
3.59	10	-	3	70	6	A	321585
3.60	10	-	3	70	6	A	321586
3.61	10	-	3	70	6	A	321587

$D_{10/+0.003}$	L_1	L_2	D_{h5}	L	Z	Ref.	HM
3.62	10	-	3	70	6	A	321588
3.63	10	-	3	70	6	A	321589
3.64	10	-	3	70	6	A	321590
3.65	10	-	3	70	6	A	321591
3.66	10	-	3	70	6	A	321592
3.67	10	-	3	70	6	A	321593
3.68	10	-	3	70	6	A	321594
3.69	10	-	3	70	6	A	321595
3.70	10	-	3	70	6	A	321596
3.71	10	-	3	70	6	A	321597
3.72	10	-	3	70	6	A	321598
3.73	10	-	3	70	6	A	321599
3.74	10	-	3	70	6	A	321600
3.75	10	-	3	70	6	A	321601
3.76	10	-	3	70	6	A	321602
3.77	10	-	3	70	6	A	321603
3.78	10	-	3	70	6	A	321604
3.79	10	-	3	70	6	A	321605
3.80	10	-	3	70	6	A	321606
3.81	10	-	3	70	6	A	321607
3.82	10	-	3	70	6	A	321608
3.83	10	-	3	70	6	A	321609
3.84	10	-	3	70	6	A	321610
3.85	10	-	3	70	6	A	321611
3.86	10	-	3	70	6	A	321612
3.87	10	-	3	70	6	A	321613
3.88	10	-	3	70	6	A	321614
3.89	10	-	3	70	6	A	321615
3.90	10	-	3	70	6	A	321616
3.91	10	-	3	70	6	A	321617
3.92	10	-	3	70	6	A	321618
3.93	10	-	3	70	6	A	321619
3.94	10	-	3	70	6	A	321620
3.95	10	-	3	70	6	A	321621
3.96	10	-	3	70	6	A	321622
3.97	10	-	3	70	6	A	321623
3.98	10	-	3	70	6	A	321624
3.99	10	-	3	70	6	A	321625
4.00	10	-	3	70	6	A	321626
4.01	10	-	3	70	6	A	321627
4.02	10	-	3	70	6	A	321628
4.03	10	-	3	70	6	A	321629
4.04	10	-	3	70	6	A	321630
4.05	10	-	3	70	6	A	321631
4.06	10	-	3	70	6	A	321632
4.07	10	-	3	70	6	A	321633
4.08	10	-	3	70	6	A	321634



POLY 4007 - 4007-TC



P. 64



> Ø 2.97

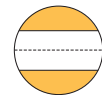

Ref. A



Ref. B

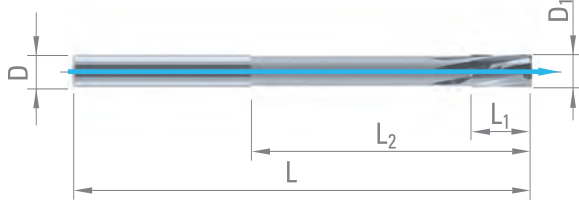

FROM STOCK
EN STOCK
库存

D _{10/+0.003}	L ₁	L ₂	D _{h5}	L	Z	Ref.	HM
4.09	10	-	3	70	6	A	321635
4.10	12	-	4	80	6	A	321636
4.11	12	-	4	80	6	A	321637
4.12	12	-	4	80	6	A	321638
4.13	12	-	4	80	6	A	321639
4.14	12	-	4	80	6	A	321640
4.15	12	-	4	80	6	A	321641
4.16	12	-	4	80	6	A	321642
4.17	12	-	4	80	6	A	321643
4.18	12	-	4	80	6	A	321644
4.19	12	-	4	80	6	A	321645
4.20	12	-	4	80	6	A	321646
4.21	12	-	4	80	6	A	321647
4.22	12	-	4	80	6	A	321648
4.23	12	-	4	80	6	A	321649
4.24	12	-	4	80	6	A	321650
4.25	12	-	4	80	6	A	321651
4.26	12	-	4	80	6	A	321652
4.27	12	-	4	80	6	A	321653
4.28	12	-	4	80	6	A	321654
4.29	12	-	4	80	6	A	321655
4.30	12	-	4	80	6	A	321656
4.31	12	-	4	80	6	A	321657
4.32	12	-	4	80	6	A	321658
4.33	12	-	4	80	6	A	321659
4.34	12	-	4	80	6	A	321660
4.35	12	-	4	80	6	A	321661
4.36	12	-	4	80	6	A	321662
4.37	12	-	4	80	6	A	321663
4.38	12	-	4	80	6	A	321664
4.39	12	-	4	80	6	A	321665
4.40	12	-	4	80	6	A	321666
4.41	12	-	4	80	6	A	321667
4.42	12	-	4	80	6	A	321668
4.43	12	-	4	80	6	A	321669
4.44	12	-	4	80	6	A	321670
4.45	12	-	4	80	6	A	321671
4.46	12	-	4	80	6	A	321672
4.47	12	-	4	80	6	A	321673
4.48	12	-	4	80	6	A	321674
4.49	12	-	4	80	6	A	321675
4.50	12	-	4	80	6	A	321676
4.51	12	-	4	80	6	A	321677
4.52	12	-	4	80	6	A	321678
4.53	12	-	4	80	6	A	321679
4.54	12	-	4	80	6	A	321680
4.55	12	-	4	80	6	A	321681

D _{10/+0.003}	L ₁	L ₂	D _{h5}	L	Z	Ref.	HM
4.56	12	-	4	80	6	A	321682
4.57	12	-	4	80	6	A	321683
4.58	12	-	4	80	6	A	321684
4.59	12	-	4	80	6	A	321685
4.60	12	-	4	80	6	A	321686
4.61	12	-	4	80	6	A	321687
4.62	12	-	4	80	6	A	321688
4.63	12	-	4	80	6	A	321689
4.64	12	-	4	80	6	A	321690
4.65	12	-	4	80	6	A	321691
4.66	12	-	4	80	6	A	321692
4.67	12	-	4	80	6	A	321693
4.68	12	-	4	80	6	A	321694
4.69	12	-	4	80	6	A	321695
4.70	12	-	4	80	6	A	321696
4.71	12	-	4	80	6	A	321697
4.72	12	-	4	80	6	A	321698
4.73	12	-	4	80	6	A	321699
4.74	12	-	4	80	6	A	321700
4.75	12	-	4	80	6	A	321701
4.76	12	-	4	80	6	A	321702
4.77	12	-	4	80	6	A	321703
4.78	12	-	4	80	6	A	321704
4.79	12	-	4	80	6	A	321705
4.80	12	-	4	80	6	A	321706
4.81	12	-	4	80	6	A	321707
4.82	12	-	4	80	6	A	321708
4.83	12	-	4	80	6	A	321709
4.84	12	-	4	80	6	A	321710
4.85	12	-	4	80	6	A	321711
4.86	12	-	4	80	6	A	321712
4.87	12	-	4	80	6	A	321713
4.88	12	-	4	80	6	A	321714
4.89	12	-	4	80	6	A	321715
4.90	12	-	4	80	6	A	321716
4.91	12	-	4	80	6	A	321717
4.92	12	-	4	80	6	A	321718
4.93	12	-	4	80	6	A	321719
4.94	12	-	4	80	6	A	321720
4.95	12	-	4	80	6	A	321721
4.96	12	-	4	80	6	A	321722
4.97	12	-	4	80	6	A	321723
4.98	12	-	4	80	6	A	321724
4.99	12	-	4	80	6	A	321725
5.00	12	-	4	80	6	A	321726
5.01	12	-	4	80	6	A	321727
5.02	12	-	4	80	6	A	321728



POLY 4007 - 4007-TC



P. 64

> Ø 2.97

Ref. A



Ref. B

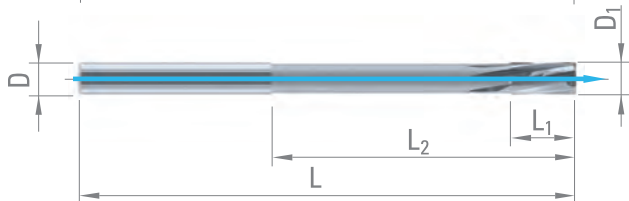

FROM STOCK
EN STOCK
库存

D _{10/+0.003}	L ₁	L ₂	D _{h5}	L	Z	Ref.	HM
5.03	12	-	4	80	6	A	321729
5.04	12	-	4	80	6	A	321730
5.05	12	-	4	80	6	A	321731
5.06	12	-	4	80	6	A	321732
5.07	12	-	4	80	6	A	321733
5.08	12	-	4	80	6	A	321734
5.09	12	-	4	80	6	A	321735
5.10	12	-	4	80	6	A	321736
5.11	12	-	4	80	6	A	321737
5.12	12	-	4	80	6	A	321738
5.13	12	-	4	80	6	A	321739
5.14	12	-	4	80	6	A	321740
5.15	12	-	4	80	6	A	321741
5.16	12	-	4	80	6	A	321742
5.17	12	-	4	80	6	A	321743
5.18	12	-	4	80	6	A	321744
5.19	12	-	4	80	6	A	321745
5.20	12	-	4	80	6	A	321746
5.21	12	-	4	80	6	A	321747
5.22	12	-	4	80	6	A	321748
5.23	12	-	4	80	6	A	321749
5.24	12	-	4	80	6	A	321750
5.25	12	-	4	80	6	A	321751
5.26	12	-	4	80	6	A	321752
5.27	12	-	4	80	6	A	321753
5.28	12	-	4	80	6	A	321754
5.29	12	-	4	80	6	A	321755
5.30	12	-	4	80	6	A	321756
5.31	12	-	4	80	6	A	321757
5.32	12	-	4	80	6	A	321758
5.33	12	-	4	80	6	A	321759
5.34	12	-	4	80	6	A	321760
5.35	12	-	4	80	6	A	321761
5.36	12	-	4	80	6	A	321762
5.37	12	-	4	80	6	A	321763
5.38	12	-	4	80	6	A	321764
5.39	12	-	4	80	6	A	321765
5.40	12	-	4	80	6	A	321766
5.41	12	-	4	80	6	A	321767
5.42	12	-	4	80	6	A	321768
5.43	12	-	4	80	6	A	321769
5.44	12	-	4	80	6	A	321770
5.45	12	-	4	80	6	A	321771
5.46	12	-	4	80	6	A	321772
5.47	12	-	4	80	6	A	321773
5.48	12	-	4	80	6	A	321774
5.49	12	-	4	80	6	A	321775

D _{10/+0.003}	L ₁	L ₂	D _{h5}	L	Z	Ref.	HM
5.50	12	-	4	80	6	A	321776
5.51	12	-	4	80	6	A	321777
5.52	12	-	4	80	6	A	321778
5.53	12	-	4	80	6	A	321779
5.54	12	-	4	80	6	A	321780
5.55	12	-	4	80	6	A	321781
5.56	12	-	4	80	6	A	321782
5.57	12	-	4	80	6	A	321783
5.58	12	-	4	80	6	A	321784
5.59	12	-	4	80	6	A	321785
5.60	12	-	4	80	6	A	321786
5.61	12	-	4	80	6	A	321787
5.62	12	-	4	80	6	A	321788
5.63	12	-	4	80	6	A	321789
5.64	12	-	4	80	6	A	321790
5.65	12	-	4	80	6	A	321791
5.66	12	-	4	80	6	A	321792
5.67	12	-	4	80	6	A	321793
5.68	12	-	4	80	6	A	321794
5.69	12	-	4	80	6	A	321795
5.70	12	-	4	80	6	A	321796
5.71	12	-	4	80	6	A	321797
5.72	12	-	4	80	6	A	321798
5.73	12	-	4	80	6	A	321799
5.74	12	-	4	80	6	A	321800
5.75	12	-	4	80	6	A	321801
5.76	12	-	4	80	6	A	321802
5.77	12	-	4	80	6	A	321803
5.78	12	-	4	80	6	A	321804
5.79	12	-	4	80	6	A	321805
5.80	12	-	4	80	6	A	321806
5.81	12	-	4	80	6	A	321807
5.82	12	-	4	80	6	A	321808
5.83	12	-	4	80	6	A	321809
5.84	12	-	4	80	6	A	321810
5.85	12	-	4	80	6	A	321811
5.86	12	-	4	80	6	A	321812
5.87	12	-	4	80	6	A	321813
5.88	12	-	4	80	6	A	321814
5.89	12	-	4	80	6	A	321815
5.90	12	-	4	80	6	A	321816
5.91	12	-	4	80	6	A	321817
5.92	12	-	4	80	6	A	321818
5.93	12	-	4	80	6	A	321819
5.94	12	-	4	80	6	A	321820
5.95	12	-	4	80	6	A	321821
5.96	12	-	4	80	6	A	321822



POLY 4007 - 4007-TC



P. 64

> Ø 2.97

FROM STOCK
EN STOCK
库存

Ref. A



Ref. B

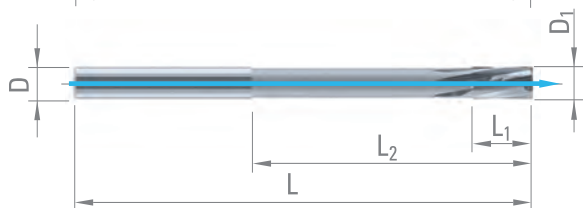

$D_{1.0/+0.003}$	L_1	L_2	D_{h5}	L	Z	Ref.	HM
5.97	12	-	4	80	6	A	321823
5.98	12	-	4	80	6	A	321824
5.99	12	-	4	80	6	A	321825
6.00	12	-	4	80	6	A	321826
6.01	12	-	4	80	6	A	321827
6.02	12	-	4	80	6	A	321828
6.03	12	-	4	80	6	A	321829
6.04	12	-	4	80	6	A	321830
6.05	12	-	4	80	6	A	321831
6.06	12	-	4	80	6	A	321832
6.07	12	-	4	80	6	A	321833
6.08	12	-	4	80	6	A	321834
6.09	12	-	4	80	6	A	321835
6.10	12	-	4	80	6	A	321836
6.11	12	-	4	80	6	A	321837
6.12	12	-	4	80	6	A	321838
6.13	12	-	4	80	6	A	321839
6.14	12	-	4	80	6	A	321840
6.15	12	-	4	80	6	A	321841
6.16	12	-	4	80	6	A	321842
6.17	12	-	4	80	6	A	321843
6.18	12	-	4	80	6	A	321844
6.19	12	-	4	80	6	A	321845
6.20	16	-	6	101	6	A	342052
6.30	16	-	6	101	6	A	342062
6.40	16	-	6	101	6	A	342072
6.50	16	-	6	101	6	A	342082
6.51	16	-	6	101	6	A	342083
6.52	16	-	6	101	6	A	342084
6.60	16	-	6	101	6	A	342092
6.70	16	-	6	101	6	A	342102
6.80	16	-	6	101	6	A	342112
6.90	16	-	6	101	6	A	342122
7.00	16	-	6	101	6	A	342132
7.01	16	-	6	101	6	A	342133
7.02	16	-	6	101	6	A	342134
7.10	16	-	6	101	6	A	342142
7.20	16	-	6	101	6	A	342152
7.30	16	-	6	101	6	A	342162
7.40	16	-	6	101	6	A	342172
7.50	16	-	6	101	6	A	342182
7.51	16	-	6	101	6	A	342183
7.52	16	-	6	101	6	A	342184
7.60	16	-	6	101	6	A	342192
7.70	16	-	6	101	6	A	342202
7.80	16	-	6	101	6	A	342212
7.90	16	-	6	101	6	A	342222

$D_{1.0/+0.003}$	L_1	L_2	D_{h5}	L	Z	Ref.	HM
7.98	16	-	6	101	6	A	342230
7.99	16	-	6	101	6	A	342231
8.00	16	-	6	101	6	A	342232
8.01	16	-	6	101	6	A	342233
8.02	16	-	6	101	6	A	342234
8.10	16	-	6	117	6	A	342242
8.20	16	-	6	117	6	A	342252
8.30	16	-	6	117	6	A	342262
8.40	16	-	6	117	6	A	342272
8.50	16	-	6	117	6	A	342282
8.51	16	-	6	117	6	A	342283
8.52	16	-	6	117	6	A	342284
8.70	16	-	6	117	6	A	342302
8.90	16	-	6	117	6	A	342322
9.00	16	-	6	117	6	A	342332
9.01	16	-	6	117	6	A	342333
9.02	16	-	6	117	6	A	342334
9.10	16	-	6	117	6	A	342342
9.50	16	-	6	117	6	A	342382
9.70	16	-	6	117	6	A	342402
10.00	16	-	6	117	6	A	342432
10.01	16	-	6	117	6	A	342433
10.02	19	87	10	133	6	B	200661
10.03	19	87	10	133	6	B	964048
10.10	19	87	10	133	6	B	200641
10.48	19	87	10	133	6	B	963732
10.49	19	87	10	133	6	B	963733
10.50	19	87	10	133	6	B	200642
10.51	19	87	10	133	6	B	963734
10.52	19	87	10	133	6	B	963735
10.60	19	87	10	133	6	B	200643
10.98	19	96	12	142	6	B	963736
10.99	19	96	12	142	6	B	963737
11.00	19	96	12	142	6	B	200644
11.01	19	96	12	142	6	B	963738
11.02	19	96	12	142	6	B	963739
11.48	19	96	12	142	6	B	963740
11.49	19	96	12	142	6	B	963741
11.50	19	96	12	142	6	B	200645
11.51	19	96	12	142	6	B	963742
11.52	19	96	12	142	6	B	963743
11.80	19	96	12	142	6	B	200646
11.98	19	105	12	151	6	B	963744
11.99	19	105	12	151	6	B	963745
12.00	19	105	12	151	6	B	200647
12.01	19	105	12	151	6	B	963746
12.02	19	105	12	151	6	B	200648



POLY 4261 - 4264

SHORT TIPPED SOLID REAMERS
 ESCARIADORES FIJOS CORTOS SOLDADOS
 非内涨式铰刀

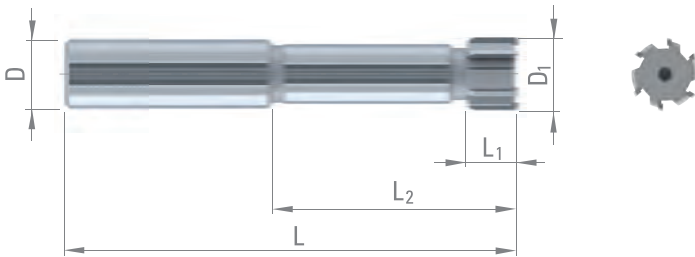

D ₁	L ₁	L ₂	D _{h6}	L	Z	HM	TiAIN	POLYCUT	C-TOP	CERMET
5.800 - 7.609	10	40	12	80	4	□	■	■	■	□
7.610 - 8.609	10	40	12	80	4	□	■	■	■	□
8.610 - 9.609	10	50	12	90	4	□	■	■	■	□
9.610 - 10.609	10	50	12	90	6	□	■	■	■	□
10.610 - 14.609	10	50	12	100	6	□	■	■	■	□
14.610 - 15.609	14	50	12	100	6	□	■	■	■	□
15.610 - 18.609	14	50	16	110	6	□	■	■	■	□
18.610 - 21.109	14	60	20	130	6	□	■	■	■	□
21.110 - 25.109	14	60	20	130	6	□	■	■	■	□
25.110 - 26.109	14	75	25	145	6	□	■	■	■	□
26.110 - 28.109	18	75	25	145	6	□	■	■	■	□
28.110 - 33.109	18	75	25	145	6	□	■	■	■	□
33.110 - 45.109	18	75	25	145	6	□	■	■	■	□
45.110 - 65.109	18	90	32	160	8	□	■	■	■	□
65.110 - 90.109	18	90	32	160	10	□	■	■	■	□
90.110 - 130.000	18	90	32	160	12	□	■	■	■	□

POLY 4261



POLY 4261-TC

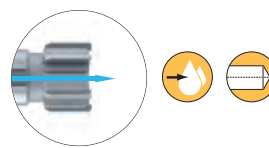

POLY 4261-FC

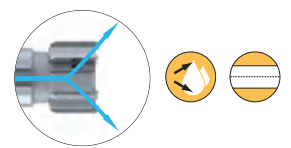

POLY 4264



POLY 4264-FC

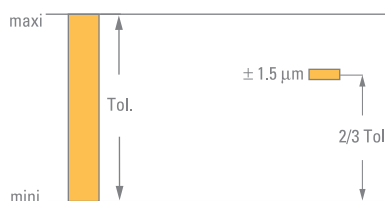

POLY 4271 - 4274

LONG TIPPED SOLID REAMERS

ESCARIADORES FIJOS LARGOS SOLDADOS

非内涨式加长型铰刀



P. 66

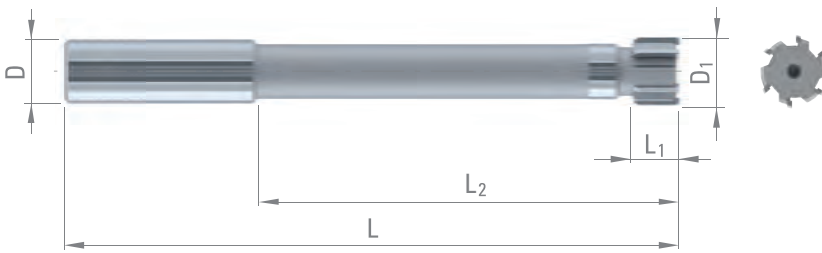

D ₁	L ₁	L ₂	D _{h6}	L	Z	HM	TiAIN	POLYCUT	C-TOP	CERMET
5.800 - 7.609	10	80	12	120	4	☐	■	■	■	☐
7.610 - 8.609	10	80	12	120	4	☐	■	■	■	☐
8.610 - 9.609	10	90	12	130	4	☐	■	■	■	☐
9.610 - 10.609	10	90	12	130	6	☐	■	■	■	☐
10.610 - 14.609	10	100	12	150	6	☐	■	■	■	☐
14.610 - 15.609	14	100	12	150	6	☐	■	■	■	☐
15.610 - 18.609	14	100	16	160	6	☐	■	■	■	☐
18.610 - 21.109	14	120	20	190	6	☐	■	■	■	☐
21.110 - 25.109	14	120	20	190	6	☐	■	■	■	☐
25.110 - 26.109	14	150	25	220	6	☐	■	■	■	☐
26.110 - 28.109	18	150	25	220	6	☐	■	■	■	☐
28.110 - 33.109	18	150	25	220	6	☐	■	■	■	☐
33.110 - 45.109	18	150	25	220	6	☐	■	■	■	☐
45.110 - 65.109	18	150	32	250	8	☐	■	■	■	☐
65.110 - 90.109	18	150	32	250	10	☐	■	■	■	☐
90.110 - 130.000	18	180	32	250	12	☐	■	■	■	☐

POLY 4271



POLY 4271-TC

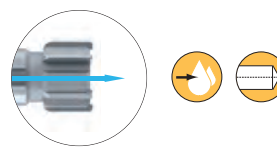

POLY 4271-FC

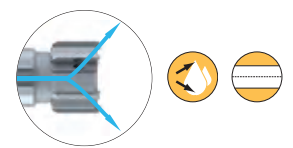

POLY 4274



POLY 4274-FC

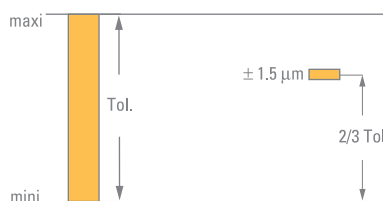

P. 73



POLY 4269

SHORT TIPPED SOLID REAMERS FOR MATERIALS > 45 HRC

ESCARIADORES FIJOS CORTOS SOLDADOS PARA MATERIALES > 45 HRC

非内涨式铰刀用于加工韧性材料 > 45 HRC

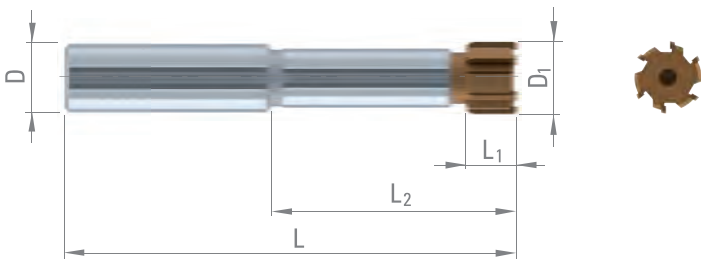

D ₁	L ₁	L ₂	D _{h6}	L	Z	C-TOP
5.800 - 7.609	10	40	12	80	4	■
7.610 - 8.609	10	40	12	80	4	■
8.610 - 9.609	10	50	12	90	4	■
9.610 - 10.609	10	50	12	90	6	■
10.610 - 14.609	10	50	12	100	6	■
14.610 - 15.609	14	50	12	100	6	■
15.610 - 18.609	14	50	16	110	6	■
18.610 - 21.109	14	60	20	130	6	■
21.110 - 25.109	14	60	20	130	6	■
25.110 - 26.109	14	75	25	145	6	■
26.110 - 28.109	18	75	25	145	6	■
28.110 - 33.109	18	75	25	145	6	■
33.110 - 45.109	18	75	25	145	6	■
45.110 - 65.109	18	90	32	160	8	■
65.110 - 90.109	18	90	32	160	10	■
90.110 - 130.000	18	90	32	160	12	■

POLY 4269



POLY 4269-TC

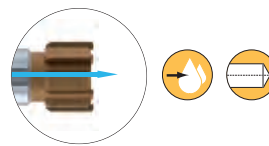

POLY 4269-FC

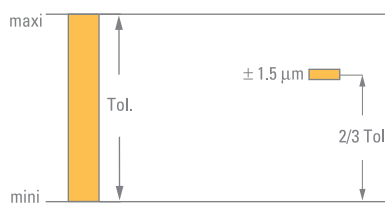
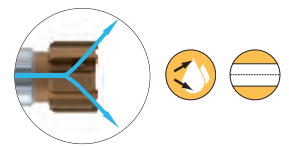

POLY 4279

LONG TIPPED SOLID REAMERS FOR MATERIALS > 45 HRC

ESCARIADORES FIJOS LARGOS SOLDADOS PARA MATERIALES > 45 HRC

非内涨式铰刀用于加工韧性材料 > 45 HRC

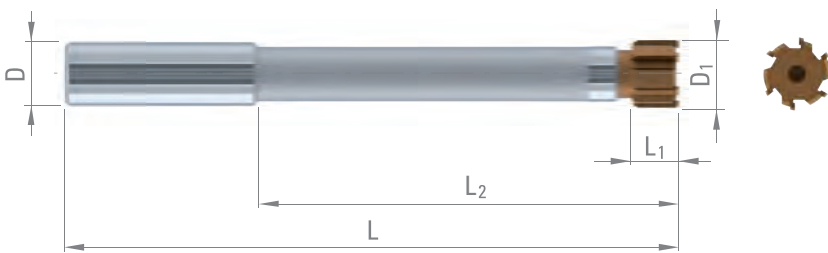

D ₁	L ₁	L ₂	D _{h6}	L	Z	C-TOP
5.800 - 7.609	10	80	12	120	4	■
7.610 - 8.609	10	80	12	120	4	■
8.610 - 9.609	10	90	12	130	4	■
9.610 - 10.609	10	90	12	130	6	■
10.610 - 14.609	10	100	12	150	6	■
14.610 - 15.609	14	100	12	150	6	■
15.610 - 18.609	14	100	16	160	6	■
18.610 - 21.109	14	120	20	190	6	■
21.110 - 25.109	14	120	20	190	6	■
25.110 - 26.109	14	150	25	220	6	■
26.110 - 28.109	18	150	25	220	6	■
28.110 - 33.109	18	150	25	220	6	■
33.110 - 45.109	18	150	25	220	6	■
45.110 - 65.109	18	180	32	250	8	■
65.110 - 90.109	18	180	32	250	10	■
90.110 - 130.000	18	180	32	250	12	■

POLY 4279

POLY 4279-TC

POLY 4279-FC

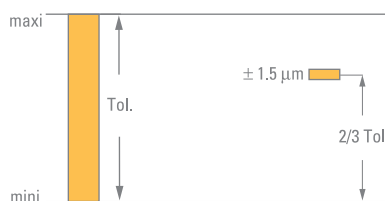
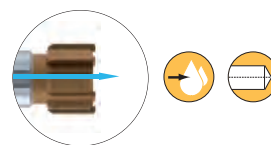



TIPPED SOLID REAMERS ON REQUEST
 ESCARIADORES FIJOS SOLDADOS SOBRE DEMANDA
 非标定制刀具

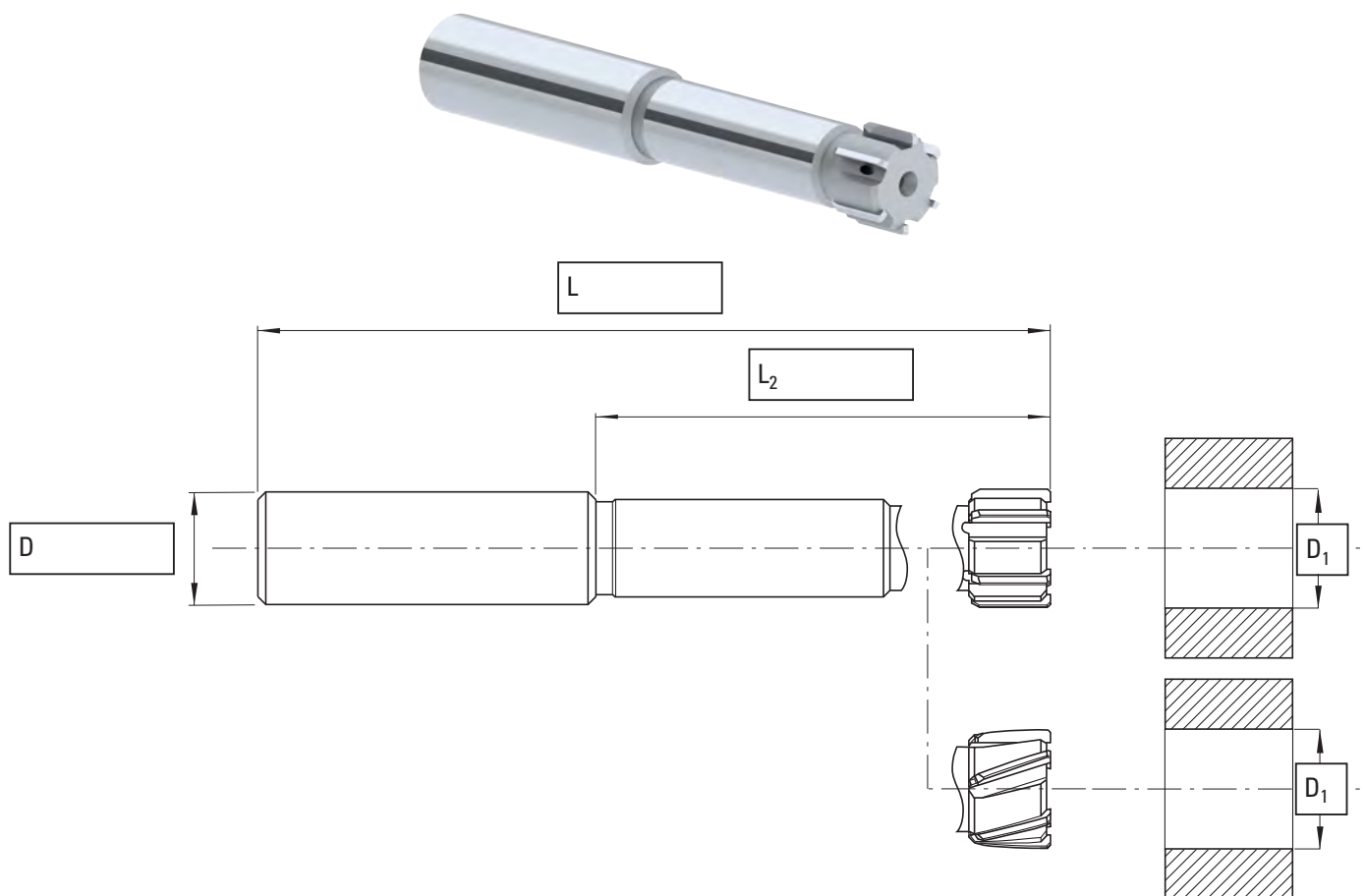

Quantity
 Cantidad
 数量

Diameter & tolerance
 of the hole to be machined
 Diámetro & tolerancias
 del agujero a mecanizar
 被加工孔的尺寸及公差

D_1

Material to be machined
 Material a mecanizar
 被加工材料

Cutting material *Material de corte* 被加工材料

HM
 CARBURO
 硬质合金

HM + TiAlN
 CARBURO + TiAlN
 硬质合金+TiAlN涂层

HM + POLY-CUT
 CARBURO + POLY-CUT
 硬质合金+POLY-CUT涂层

HM + C-TOP
 CARBURO + C-TOP
 硬质合金+C-TOP涂层

CERMET
 金属陶瓷

Other:
 Otro:
 其它: _____

Cooling *Refrigeración* 冷却

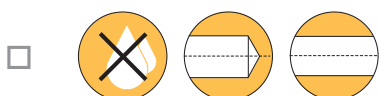

VISIT OUR E-QUOTATION ON
 CONSULTE NUESTRO FORMULARIO DE SOLICITUD DE OFERTA ON-LINE EN
 访问我们的在线询价网址

WWW.DIXIPOLYTOOL.COM





TIPPED EXPANDABLE REAMERS
ESCARIADORES EXPANSIBLES SOLDADOS
内涨式铰刀



SHORT TIPPED EXPANDABLE REAMERS
ESCARIADORES EXPANSIBLES CORTOS SOLDADOS
短型焊接式内涨铰刀

32

FROM STOCK
EN STOCK
库存



LONG TIPPED EXPANDABLE REAMERS
ESCARIADORES EXPANSIBLES LARGOS SOLDADOS
长型焊接式内涨铰刀

34

FROM STOCK
EN STOCK
库存



SHORT TIPPED EXPANDABLE REAMERS
ESCARIADORES EXPANSIBLES CORTOS SOLDADOS
短型焊接式内涨铰刀

36



LONG TIPPED EXPANDABLE REAMERS
ESCARIADORES EXPANSIBLES LARGOS SOLDADOS
长型焊接式内涨铰刀

37

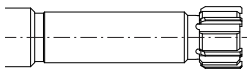

TIPPED EXPANDABLE REAMERS ON REQUEST
ESCARIADORES EXPANSIBLES SOLDADOS SOBRE DEMANDA
非标内涨式焊接铰刀

38



CUTTING RING & EXPANSION TECHNOLOGY
TECNOLOGÍA ANILLOS DE CORTE & EXPANSIÓN
切削环 技术 铰削环&内涨技术

39

POLY 4361

SHORT TIPPED EXPANDABLE REAMERS
 ESCARIADORES EXPANSIBLES CORTOS SOLDADOS
 短型焊接式内涨铰刀



P. 66

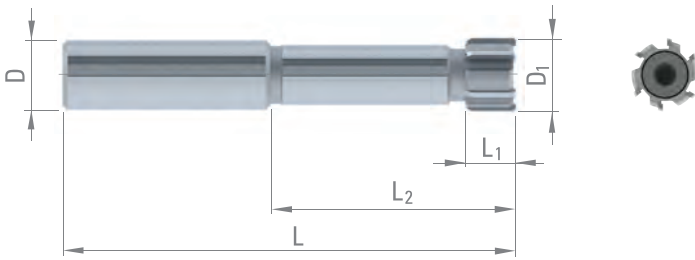
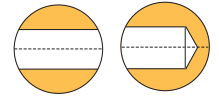

FROM STOCK
 EN STOCK
 库存

POLY 4361

POLY 4361-TC

POLY 4361-FC



D nom.
H7

D₁
± 1.5 μm

L₁

L₂

D_{h6}

L

Z

POLY

HM

TAIIN

CERMET

6.00	(6.006)	10	40	12	80	4	4361	61859	965576	963287
							4361-TC	61883	341107	964213
							4361-FC	326753	955517	955527
7.00	(7.007)	10	40	12	80	4	4361	63863	341096	341122
							4361-TC	341082	341108	964215
							4361-FC	977363	955518	955528
8.00	(8.007)	10	40	12	80	4	4361	61860	341097	61594
							4361-TC	61884	958621	62263
							4361-FC	966766	955519	955529
9.00	(9.007)	10	50	12	90	4	4361	954994	341098	341123
							4361-TC	974647	341109	61671
							4361-FC	969137	955520	955530
10.00	(10.007)	10	50	12	100	6	4361	61666	987470	971287
							4361-TC	61885	985270	305651
							4361-FC	970436	955521	955531
11.00	(11.009)	10	50	12	100	6	4361	953002	341099	341124
							4361-TC	341083	341110	952860
							4361-FC	341089	982623	957205
12.00	(12.009)	10	50	12	100	6	4361	61862	953717	956390
							4361-TC	61886	957400	61823
							4361-FC	961924	955522	955532
13.00	(13.009)	10	50	12	100	6	4361	953441	953899	341125
							4361-TC	951466	62899	951704
							4361-FC	956383	994806	341139
14.00	(14.009)	10	50	12	100	6	4361	61709	950932	341126
							4361-TC	61045	957939	64881
							4361-FC	965308	955523	955533
15.00	(15.009)	14	50	12	100	6	4361	952323	953408	66609
							4361-TC	955048	341111	62055
							4361-FC	964856	341118	961253

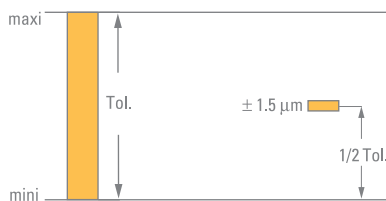

P. 73



POLY 4361



P. 66

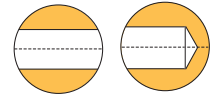

FROM STOCK
EN STOCK
库存

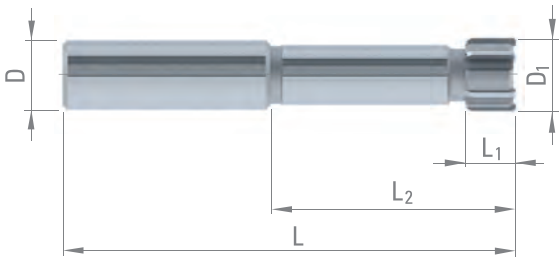

POLY 4361

POLY 4361-TC

POLY 4361-FC



D nom.
H7

D₁
± 1.5 μm

L₁

L₂

D_{h6}

L

Z

POLY

HM

TA1N

CERMET

D nom. H7	D ₁ ± 1.5 μm	L ₁	L ₂	D _{h6}	L	Z	POLY	HM	TA1N	CERMET
16.00	(16.009)	14	50	16	100	6	4361	61863	953900	990911
							4361-TC	61044	341112	60455
							4361-FC	959763	955524	955534
17.00	(17.010)	14	50	16	110	6	4361	67322	341100	341127
							4361-TC	320133	308083	341132
							4361-FC	341090	964572	959907
18.00	(18.010)	14	50	16	110	6	4361	61864	341101	965018
							4361-TC	61887	341113	341133
							4361-FC	964631	955525	955535
19.00	(19.010)	14	60	20	130	6	4361	971893	341102	341128
							4361-TC	341084	341114	341134
							4361-FC	341091	969769	985097
20.00	(20.010)	14	60	20	130	6	4361	61866	341103	965020
							4361-TC	61888	65708	341135
							4361-FC	965283	955526	955536
21.00	(21.010)	14	60	20	130	6	4361	959277	341104	341129
							4361-TC	341085	341115	341136
							4361-FC	983187	341119	959112
22.00	(22.010)	14	60	20	130	6	4361	61867	953901	965019
							4361-TC	341086	341116	341137
							4361-FC	341093	959097	965586
23.00	(23.010)	14	60	20	130	6	4361	956588	341105	341130
							4361-TC	341087	341117	341138
							4361-FC	341094	341120	341140
24.00	(24.010)	14	60	20	130	6	4361	61868	341106	341131
							4361-TC	341088	968505	969504
							4361-FC	341095	341121	962965

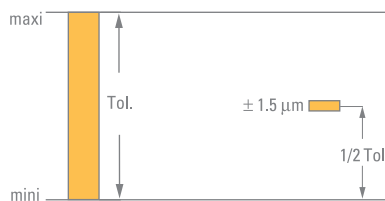

P. 73



POLY 4371

LONG TIPPED EXPANDABLE REAMERS
 ESCARIADORES EXPANSIBLES LARGOS SOLDADOS
 长型焊接式内涨铰刀

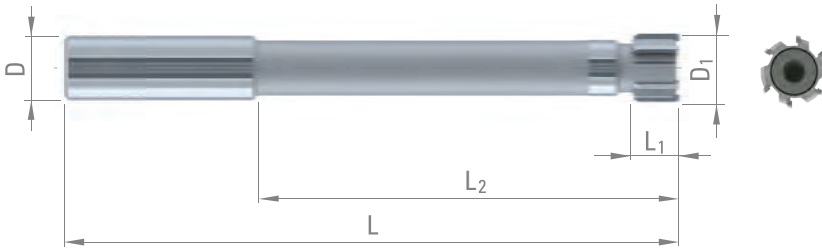
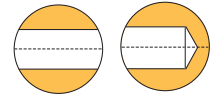

**FROM STOCK
 EN STOCK
 库存**

POLY 4371

POLY 4371-TC

POLY 4371-FC



D nom. H7	D ₁ ± 1.5µm	L ₁	L ₂	D _{h6}	L	Z	POLY	HM	TIAIN	CERMET
6.00	(6.006)	10	80	12	120	4	4371	61869	341156	341186
							4371-TC	958107	965969	341204
							4371-FC	976190	955537	955547
7.00	(7.007)	10	80	12	120	4	4371	950528	341157	341187
							4371-TC	968331	341166	341205
							4371-FC	956371	955538	955548
8.00	(8.007)	10	80	12	120	4	4371	61870	341158	341188
							4371-TC	341141	341167	967206
							4371-FC	973938	955539	955549
9.00	(9.007)	10	90	12	130	4	4371	954860	341159	341189
							4371-TC	950120	341168	341206
							4371-FC	976838	955540	955550
10.00	(10.007)	10	90	12	130	6	4371	61871	310374	341190
							4371-TC	341142	341169	341207
							4371-FC	962768	955541	955551
11.00	(11.009)	10	100	12	150	6	4371	972464	982208	341191
							4371-TC	341143	341170	341208
							4371-FC	312249	959071	341221
12.00	(12.009)	10	100	12	150	6	4371	61872	310375	341192
							4371-TC	962624	341171	341209
							4371-FC	986143	955542	955552
13.00	(13.009)	10	100	12	150	6	4371	952545	341160	341193
							4371-TC	341144	341172	341210
							4371-FC	972342	977697	341222
14.00	(14.009)	10	100	12	150	6	4371	61873	310950	965516
							4371-TC	341145	341173	341211
							4371-FC	964796	955543	955553
15.00	(15.009)	14	100	12	150	6	4371	64404	304409	341194
							4371-TC	341146	341174	341212
							4371-FC	965648	976749	341223

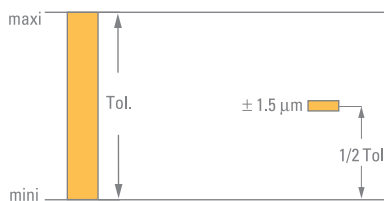

POLY 4371



P. 66

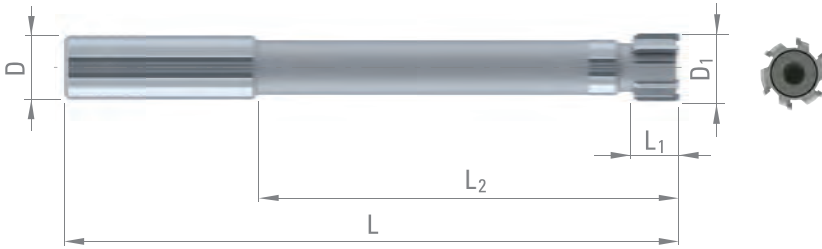
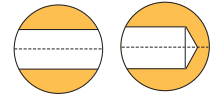

FROM STOCK
EN STOCK
库存

POLY 4371

POLY 4371-TC

POLY 4371-FC



D nom.
H7

D₁
± 1.5 μm

L₁

L₂

D_{h6}

L

Z

POLY

HM

TIAlN

CERMET

16.00	(16.009)	14	100	16	160	6	4371	61874	964387	341195
							4371-TC	977762	341175	341213
							4371-FC	982330	955544	955554
17.00	(17.010)	14	100	16	160	6	4371	960993	59895	341196
							4371-TC	341147	341176	341214
							4371-FC	341152	341184	341224
18.00	(18.010)	14	100	16	160	6	4371	61875	310376	341197
							4371-TC	961483	341177	341215
							4371-FC	962767	955545	955555
19.00	(19.010)	14	120	20	190	6	4371	66588	341161	341198
							4371-TC	319972	341178	320656
							4371-FC	955676	967797	341225
20.00	(20.010)	14	120	20	190	6	4371	61876	341162	341199
							4371-TC	400483	341179	341216
							4371-FC	341153	955546	955556
21.00	(21.010)	14	120	20	190	6	4371	334784	341163	341200
							4371-TC	341148	341180	341217
							4371-FC	994332	310771	983957
22.00	(22.010)	14	120	20	190	6	4371	963583	964388	341201
							4371-TC	341149	341181	341218
							4371-FC	341154	965966	341226
23.00	(23.010)	14	120	20	190	6	4371	963174	341164	341202
							4371-TC	341150	341182	341219
							4371-FC	962757	310773	341227
24.00	(24.010)	14	120	20	190	6	4371	62827	341165	341203
							4371-TC	341151	341183	341220
							4371-FC	341155	341185	341228

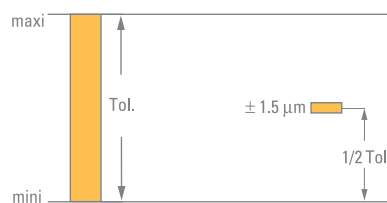

P. 73



POLY 4371 - 4374

LONG TIPPED EXPANDABLE REAMERS
 ESCARIADORES EXPANSIBLES LARGOS SOLDADOS
 长型焊接式内涨铰刀

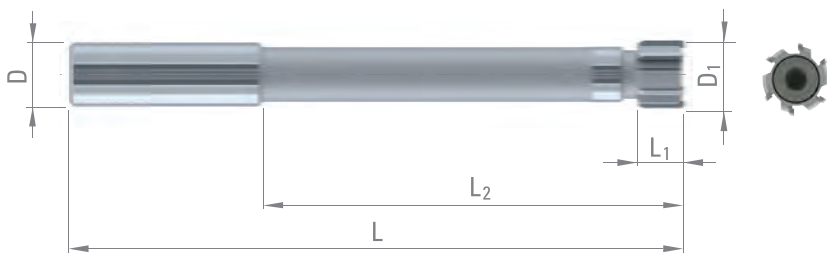

D ₁	L ₁	L ₂	D _{h6}	L	Z	HM	TiAIN	POLYCUT	C-TOP	CERMET
5.800 - 7.609	10	80	12	120	4	☐	■	■	■	☐
7.610 - 8.609	10	80	12	120	4	☐	■	■	■	☐
8.610 - 9.609	10	90	12	130	4	☐	■	■	■	☐
9.610 - 10.609	10	90	12	130	6	☐	■	■	■	☐
10.610 - 14.609	10	100	12	150	6	☐	■	■	■	☐
14.610 - 15.609	14	100	12	150	6	☐	■	■	■	☐
15.610 - 18.609	14	100	16	160	6	☐	■	■	■	☐
18.610 - 21.109	14	120	20	190	6	☐	■	■	■	☐
21.110 - 25.109	14	120	20	190	6	☐	■	■	■	☐
25.110 - 26.109	14	150	25	220	6	☐	■	■	■	☐
26.110 - 28.109	18	150	25	220	6	☐	■	■	■	☐
28.110 - 45.109	18	150	25	220	6	☐	■	■	■	☐
45.110 - 55.000	18	180	32	250	8	☐	■	■	■	☐

From Ø 55 to Ø 130 on request
 De Ø 55 a Ø 130 sobre demanda
 直径从 Ø 55 至 Ø 130, 按需定制



P. 39

POLY 4371



POLY 4371-TC

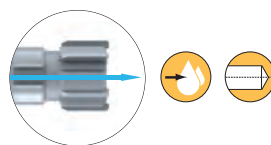

POLY 4371-FC



POLY 4374



POLY 4374-FC

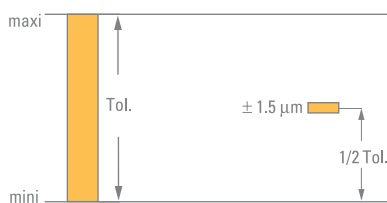

P. 73



POLY 4371 - 4374

LONG TIPPED EXPANDABLE REAMERS
 ESCARIADORES EXPANSIBLES LARGOS SOLDADOS
 长型焊接式内涨铰刀

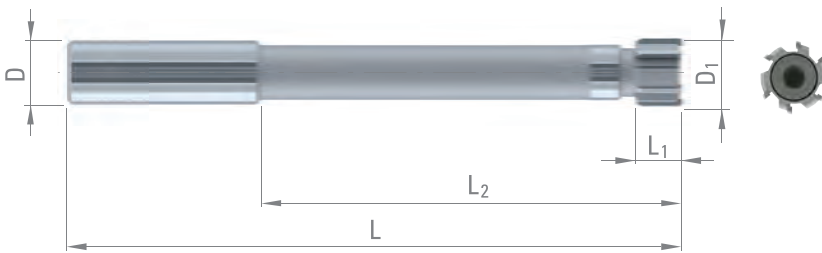

D ₁	L ₁	L ₂	D _{h6}	L	Z	HM	TiAIN	POLYCUT	C-TOP	CERMET
5.800 - 7.609	10	80	12	120	4	☐	■	■	■	☐
7.610 - 8.609	10	80	12	120	4	☐	■	■	■	☐
8.610 - 9.609	10	90	12	130	4	☐	■	■	■	☐
9.610 - 10.609	10	90	12	130	6	☐	■	■	■	☐
10.610 - 14.609	10	100	12	150	6	☐	■	■	■	☐
14.610 - 15.609	14	100	12	150	6	☐	■	■	■	☐
15.610 - 18.609	14	100	16	160	6	☐	■	■	■	☐
18.610 - 21.109	14	120	20	190	6	☐	■	■	■	☐
21.110 - 25.109	14	120	20	190	6	☐	■	■	■	☐
25.110 - 26.109	14	150	25	220	6	☐	■	■	■	☐
26.110 - 28.109	18	150	25	220	6	☐	■	■	■	☐
28.110 - 45.009	18	150	25	220	6	☐	■	■	■	☐
45.110 - 55.000	18	150	32	220	8	☐	■	■	■	☐

From Ø 55 to Ø 130 on request
 De Ø 55 a Ø 130 sobre demanda
 直径从 Ø 55 至 Ø 130, 按需定制



P. 39

POLY 4371



POLY 4371-TC

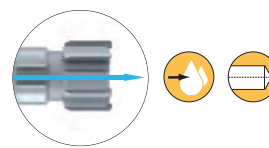

POLY 4371-FC

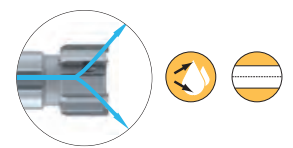

POLY 4374



POLY 4374-FC

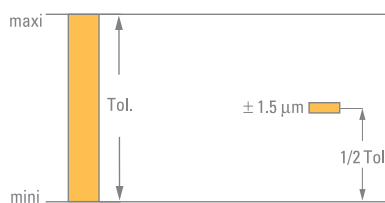

P. 73



EXPANDABLE TIPPED REAMERS ON REQUEST
 ESCARIADORES EXPANSIBLES SOLDADOS SOBRE DEMANDA
 非标内涨式焊接铰刀

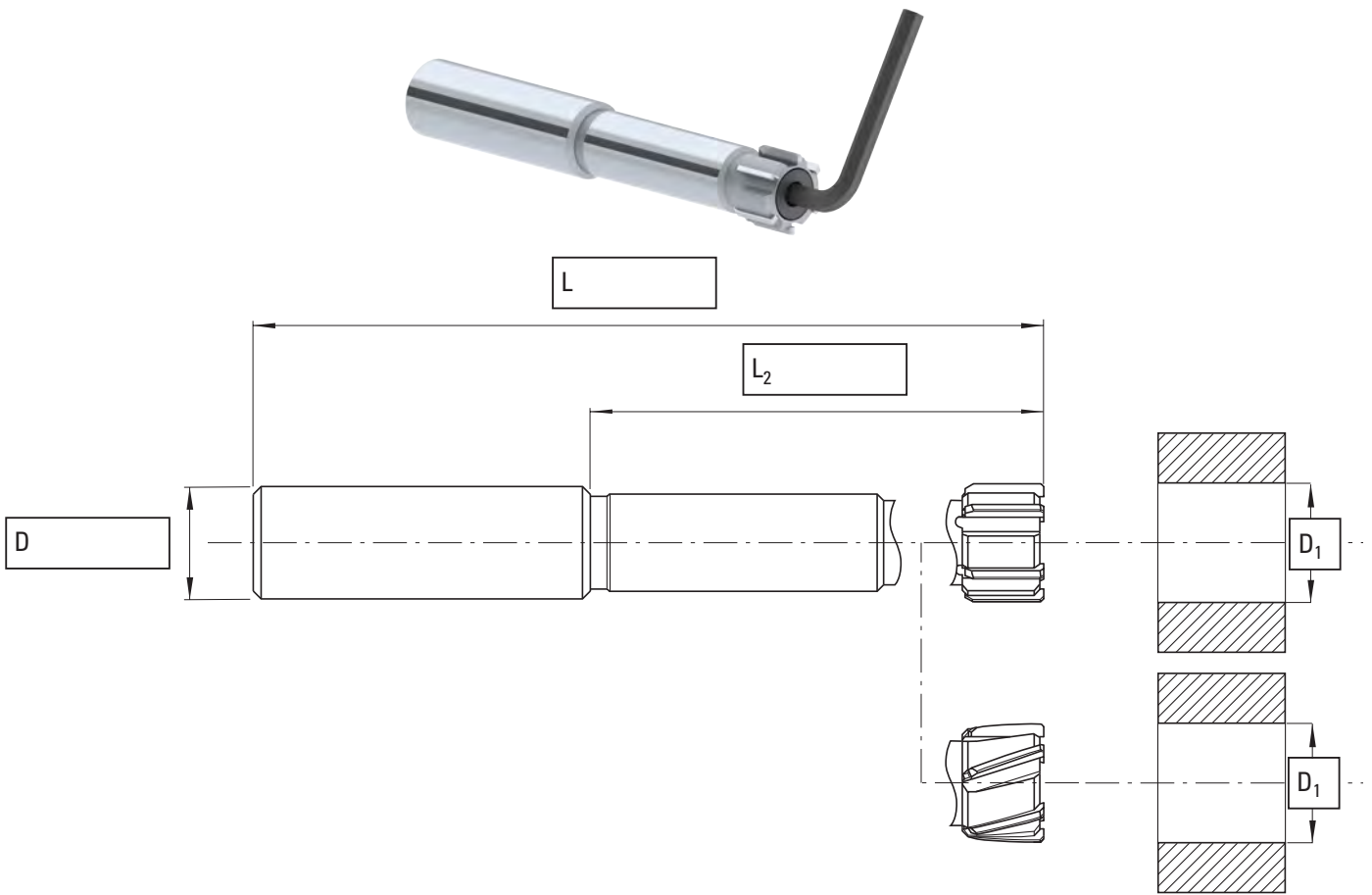

Quantity
 Cantidad
 数量

Diameter & tolerance
 of the hole to be machined
 Diámetro & tolerancias
 del agujero a mecanizar
 被加工孔的尺寸及公差

D_1

Material to be machined
 Material a mecanizar
 被加工材料

Cutting material *Material de corte* 被加工材料

HM
 CARBURO
 硬质合金

HM + TiAlN
 CARBURO + TiAlN
 硬质合金+TiAlN涂层

HM + POLY-CUT
 CARBURO + POLY-CUT
 硬质合金+POLY-CUT涂层

HM + C-TOP
 CARBURO + C-TOP
 硬质合金+C-TOP涂层

CERMET
 金属陶瓷

Other:
 Otro:
 其它:

Cooling *Refrigeración* 冷却

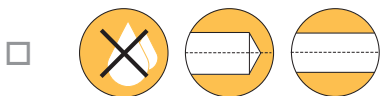

VISIT OUR E-QUOTATION ON
 CONSULTE NUESTRO FORMULARIO DE SOLICITUD DE OFERTA ON-LINE EN
 访问我们的在线询价网址

WWW.DIXIPOLYTOOL.COM





Expandable cutting ring system from Ø 55 to Ø 130 on request

Sistema de anillos de corte con anillos de corte extensibles de Ø 55 a Ø 130 sobre demanda

根据客户需求，切削环可提供从 Ø 55 至 Ø 130



EXPANSION TECHNOLOGY
TECNOLOGÍA EXPANSIÓN
内涨式铰刀系统 技术

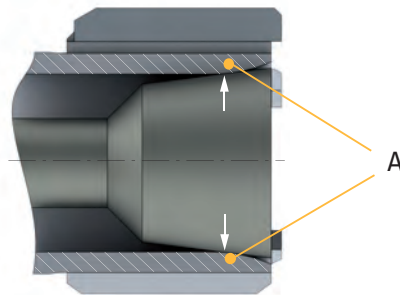

Expansion system

Advantages of the expandable reamers:

- Adjustment at the midpoint of the tolerance for any application
- Wear compensation, therefore improving tool life

The POLYTOOL expansion system is applied to the expansible reamers, heads and cutting rings.

Introducing a taper into the convex part allows buckling of the tool.

Thanks to the perfectly defined contact circle (A), the adjustment of the reamer is very precise.

Even after several expansions, the precision and the performance of the reamer remain unchanged.

Sistema de expansión

Ventajas de los escariadores expansibles:

- *Ajuste en la mitad de la tolerancia para cada aplicación*
- *Compensación de uso, por lo tanto se prolonga su duración*

El sistema de expansión POLYTOOL es aplicado a los escariadores, con cabezales y anillos de corte expansibles.

Un cono introducido en una pieza convexa permite su deformación.

Gracias al círculo de contacto (A) perfectamente definido, el reglaje del escariador es muy preciso.

Después de varias expansiones, la precisión y el resultado del escariador permanecen inalterables.

内涨式铰刀系统

内涨式铰刀优点：

- 对于任何应用，尺寸可以从公差的中点位置开始调节
- 磨损补偿，所以可以提高刀具寿命

POLYTOOL 内涨系统包含内涨式铰刀，铰削头，铰削环。

凸起部分带锥度可以锁住刀具。

由于接触圆 (A) 的精确设计，铰刀的调整是非常精确的。

即使经过几次内涨后，铰刀的精度和性能依旧可以保持不变。





SOLID & EXPANDABLE HEADS
CABEZALES FIJOS & EXPANSIBLES
内涨式&非内涨式铰削头



TIPPED SOLID HEADS
CABEZALES FIJOS SOLDADOS
非内涨式铰削头

42



TIPPED EXPANDABLE HEADS
CABEZALES EXPANSIBLES SOLDADOS
内涨式铰削头

44



SOLID CARBIDE HEADS
CABEZALES EN CARBURO
整硬铰削头

46



HOLDERS FOR HEADS
MANDRINOS PARA CABEZALES
刀杆用于铰削头

48



ADAPTORS FOR HEADS
ADAPTADORES PARA CABEZALES
连接单元用于铰削头

49

POLY 4401 - 4404

TIPPED SOLID HEADS
 CABEZALES FIJOS SOLDADOS
 非内涨式铰削头



POLY 4401

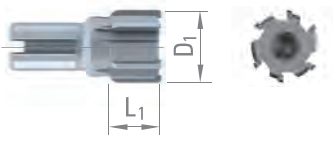

POLY 4404

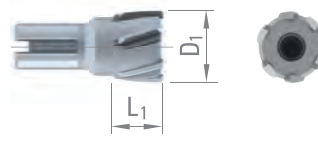

D ₁	L ₁	Z	HM	TiAIN	POLYCUT	C-TOP	CERMET
9.600 - 11.609	10	6	☐	■	■	■	□
11.610 - 12.609	10	6	☐	■	■	■	□
12.610 - 14.609	10	6	☐	■	■	■	□
14.610 - 15.609	14	6	☐	■	■	■	□
15.610 - 18.609	14	6	☐	■	■	■	□
18.610 - 23.109	14	6	☐	■	■	■	□
23.110 - 26.109	14	6	☐	■	■	■	□
26.110 - 28.109	18	6	☐	■	■	■	□
28.110 - 31.109	18	6	☐	■	■	■	□
31.110 - 45.109	18	6	☐	■	■	■	□
45.110 - 55.000	18	8	☐	■	■	■	□

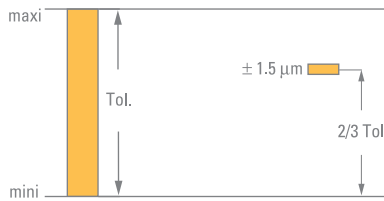

POLY 8002 / POLY 8004

P.48

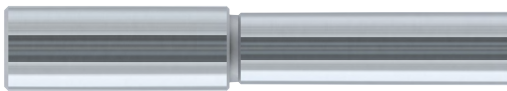

POLY 4401



POLY 6046

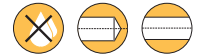

POLY 4404



POLY 6046



POLY 8002 / POLY 8004

P.48

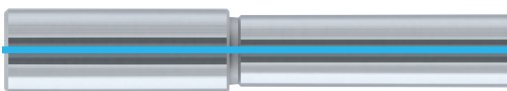

POLY 4401



POLY 6046-TC



POLY 4401-FC



POLY 6046-FC



POLY 4404-FC



POLY 6046-FC



POLY 6046

SCREWS FOR TIPPED SOLID HEADS

TORNILLOS PARA CABEZALES FIJOS SOLDADOS

螺丝用于非内涨焊接式铰削头



POLY 6046



POLY 6046-TC



POLY 6046-FC

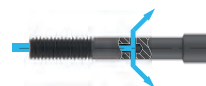

D_1	Art.	Art.	Art.	M
9.600 - 12.609	400095	400136	962691	3 x 0.35
12.610 - 15.609	400096	400137	961366	4 x 0.50
15.610 - 18.609	400097	400138	962725	5 x 0.50
18.610 - 23.109	400098	400139	963091	6 x 0.50
23.110 - 31.109	400099	400140	962423	8 x 0.75
31.110 - 55.000	400100	400141	962225	12 x 0.75

POLY 4501 - 4504

TIPPED EXPANDABLE HEADS
 CABEZALES EXPANSIBLES SOLDADOS
 内涨式铰削头



POLY 4501

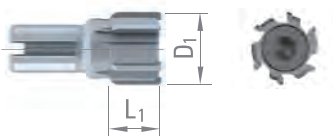

POLY 4504

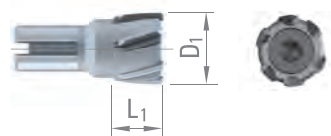

D ₁	L ₁	Z	HM	TiAIN	POLYCUT	C-TOP	CERMET
9.600 - 11.609	10	6	☐	■	■	■	☐
11.610 - 12.609	10	6	☐	■	■	■	☐
12.610 - 14.609	10	6	☐	■	■	■	☐
14.610 - 15.609	14	6	☐	■	■	■	☐
15.610 - 18.609	14	6	☐	■	■	■	☐
18.610 - 23.109	14	6	☐	■	■	■	☐
23.110 - 26.109	14	6	☐	■	■	■	☐
26.110 - 28.109	18	6	☐	■	■	■	☐
28.110 - 31.109	18	6	☐	■	■	■	☐
31.110 - 45.109	18	6	☐	■	■	■	☐
45.110 - 55.000	18		☐	■	■	■	☐

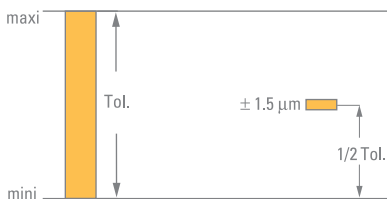

POLY 8002 / POLY 8004 P.48

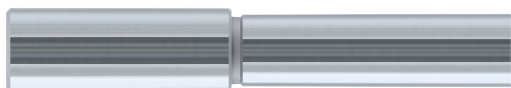

POLY 4501



POLY 6048

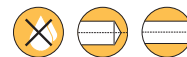

POLY 4504



POLY 6048



POLY 8002 / POLY 8004 P.48

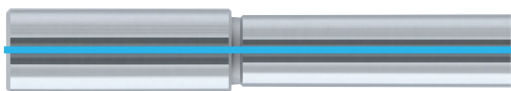

POLY 4501



POLY 6048-TC



POLY 4501-FC



POLY 6048-FC



POLY 4504-FC



POLY 6048-FC



POLY 6048

SCREWS FOR TIPPED EXPANDABLE HEADS

TORNILLOS PARA CABEZALES EXPANSIBLES SOLDADOS

螺丝用于内涨焊接式铰削头

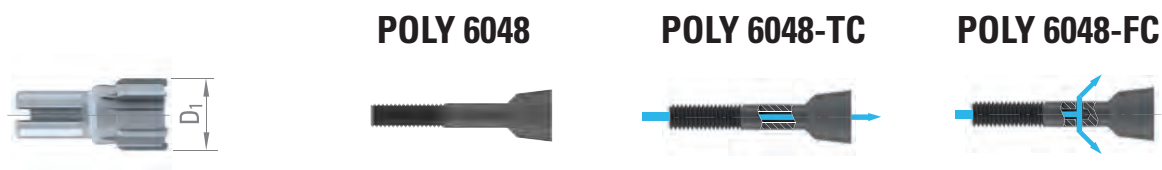

D ₁	Art.	Art.	Art.	M
9.600 - 10.609	400142	400169	954590	3 x 0.35
10.610 - 11.609	400143	400170	954593	3 x 0.35
11.610 - 12.609	400144	400171	954594	3 x 0.35
12.610 - 13.609	400145	400172	954595	4 x 0.50
13.610 - 14.609	400146	400173	954596	4 x 0.50
14.610 - 15.609	400147	400174	954597	4 x 0.50
15.610 - 16.609	400148	400175	954598	5 x 0.50
16.610 - 17.609	400149	400176	954599	5 x 0.50
17.610 - 18.609	400150	400177	954600	5 x 0.50
18.610 - 19.109	400151	400178	954601	6 x 0.50
19.110 - 20.109	400152	400179	954602	6 x 0.50
20.110 - 21.109	400153	400180	954603	6 x 0.50
21.110 - 22.109	400154	400181	954604	6 x 0.50
22.110 - 23.109	400155	400182	954605	6 x 0.50
23.110 - 24.109	400156	400183	954606	8 x 0.75
24.110 - 25.109	400157	400184	954607	8 x 0.75
25.110 - 26.109	400158	400185	954608	8 x 0.75
26.110 - 27.109	400159	400186	954609	8 x 0.75
27.110 - 28.109	400160	400187	954610	8 x 0.75
28.110 - 29.109	401203	401202	954611	8 x 0.75
29.110 - 31.109	400161	400188	954612	8 x 0.75
31.110 - 33.109	400162	400189	954613	12 x 0.75
33.110 - 35.109	400163	400190	954614	12 x 0.75
35.110 - 37.109	400164	400191	954615	12 x 0.75
37.110 - 39.109	400165	400192	954616	12 x 0.75
39.110 - 41.109	400166	400193	954617	12 x 0.75
41.110 - 43.109	400167	400194	954618	12 x 0.75
43.110 - 45.000	400168	400195	954620	12 x 0.75

POLY 4411-FC - 4414-FC

SOLID CARBIDE HEADS
 CABEZALES EN CARBURO
 非内涨式铰削头



POLY 4411-FC

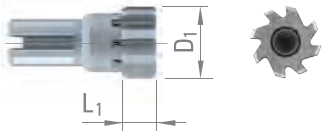

POLY 4414-FC

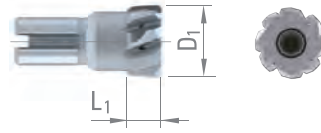

D ₁	L ₁	Z	HM	TiAIN	POLYCUT	C-TOP
9.600 - 11.609	9.7	6	<input type="checkbox"/>	<input checked="" type="checkbox"/>	<input checked="" type="checkbox"/>	<input checked="" type="checkbox"/>
11.610 - 12.609	9.7	6	<input type="checkbox"/>	<input checked="" type="checkbox"/>	<input checked="" type="checkbox"/>	<input checked="" type="checkbox"/>
12.610 - 15.609	9.7	6	<input type="checkbox"/>	<input checked="" type="checkbox"/>	<input checked="" type="checkbox"/>	<input checked="" type="checkbox"/>
15.610 - 18.609	9.7	6	<input type="checkbox"/>	<input checked="" type="checkbox"/>	<input checked="" type="checkbox"/>	<input checked="" type="checkbox"/>
18.610 - 23.109	9.7	8	<input type="checkbox"/>	<input checked="" type="checkbox"/>	<input checked="" type="checkbox"/>	<input checked="" type="checkbox"/>
23.110 - 26.109	9.7	8	<input type="checkbox"/>	<input checked="" type="checkbox"/>	<input checked="" type="checkbox"/>	<input checked="" type="checkbox"/>
26.110 - 28.109	9.7	8	<input type="checkbox"/>	<input checked="" type="checkbox"/>	<input checked="" type="checkbox"/>	<input checked="" type="checkbox"/>
28.110 - 31.109	9.7	8	<input type="checkbox"/>	<input checked="" type="checkbox"/>	<input checked="" type="checkbox"/>	<input checked="" type="checkbox"/>
31.110 - 45.000	9.7	8	<input type="checkbox"/>	<input checked="" type="checkbox"/>	<input checked="" type="checkbox"/>	<input checked="" type="checkbox"/>

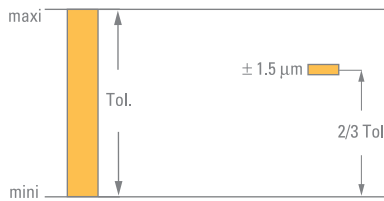

POLY 8002 / POLY 8004 P.48



POLY 4411-FC



POLY 6046

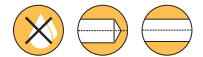

POLY 4414-FC



POLY 6046



POLY 8002 / POLY 8004 P.48

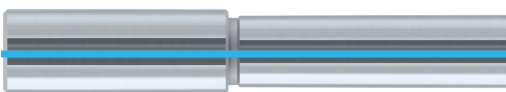

POLY 4411-FC



POLY 6046-TC



POLY 4411-FC



POLY 6046-FC



POLY 4414-FC



POLY 6046-FC



POLY 6046

SCREWS FOR SOLID CARBIDE HEAD
 TORNILLOS PARA CABEZALES EN CARBURO
 螺丝用于整硬铰削头



POLY 6046



POLY 6046-TC



POLY 6046-FC

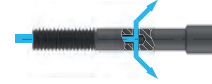

D_1	Art.	Art.	Art.	M
9.600 - 12.609	400095	400136	962691	3 x 0.35
12.610 - 15.609	400096	400137	961366	4 x 0.50
15.610 - 18.609	400097	400138	962725	5 x 0.50
18.610 - 23.109	400098	400139	963091	6 x 0.50
23.110 - 31.109	400099	400140	962423	8 x 0.75
31.110 - 45.000	400100	400141	962225	12 x 0.75

POLY 8002

SHORT HOLDERS FOR HEADS

MANDRINOS CORTOS PARA CABEZALES

刀杆用于铰削头，短型

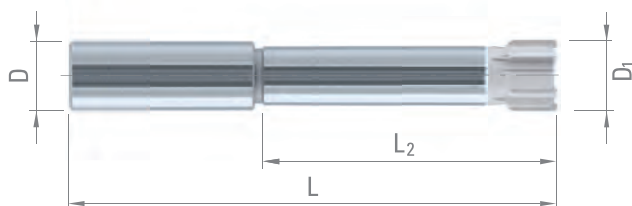

D_1	L_2	D_{h6}	L	Art.
9.600 - 12.609	55	12	100	955635
12.610 - 15.609	70	16	118	955636
15.610 - 18.609	71	20	121	955637
18.610 - 23.109	90	20	140	955638
23.110 - 31.109	110	25	166	955639
31.110 - 45.000	115	25	171	955791

Expansion or fixing screws supplied separately

Tornillos de expansión o fijación suministrados por separado

内涨或固定螺丝需要单独订购

POLY 8004

LONG HOLDERS FOR HEADS

MANDRINOS LARGOS PARA CABEZALES

刀杆用于铰削头，长型

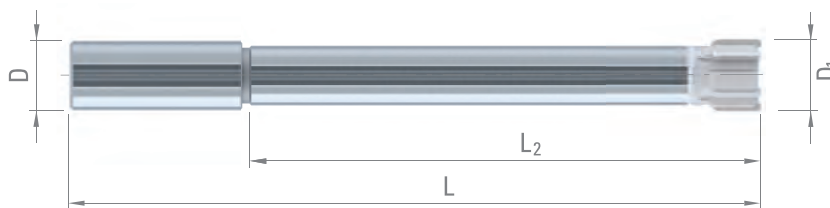

D_1	L_2	D_{h6}	L	Art.
9.600 - 12.609	100	12	145	955641
12.610 - 15.609	110	16	158	955642
15.610 - 18.609	130	20	180	955643
18.610 - 23.109	150	20	200	955644
23.110 - 31.109	160	25	215	955645
31.110 - 45.000	160	25	215	955969

Expansion or fixing screws supplied separately

Tornillos de expansión o fijación suministrados por separado

内涨或固定螺丝需要单独订购

ADAPTORS FOR HEADS
 ADAPTADORES PARA CABEZALES
 连接单元用于铰削头



P. 72

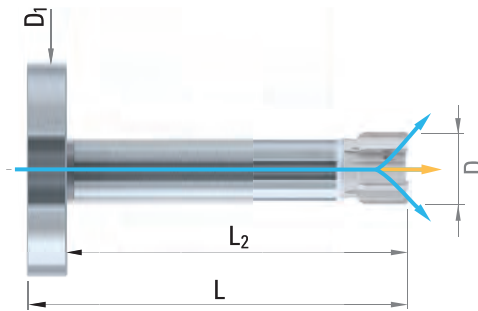

D	D ₁	L	L ₂	Art.
9.600 - 12.609	40	69	60	401222
12.610 - 15.609	40	84	75	401223
15.610 - 18.609	60	86	75	401224
18.610 - 23.109	60	106	95	401225
23.110 - 31.109	71	129	115	401226
31.110 - 45.000	71	134	120	401227
9.600 - 12.609	71	119	105	401228
12.610 - 15.609	71	129	115	401229
15.610 - 18.609	71	149	135	401230
18.610 - 23.109	71	169	155	401231
23.110 - 31.109	71	179	165	401232
31.110 - 45.000	71	179	165	401233

Expansion or fixing screws supplied separately

Tornillos de expansión o fijación suministrados por separado

内涨或固定螺丝需要单独订购

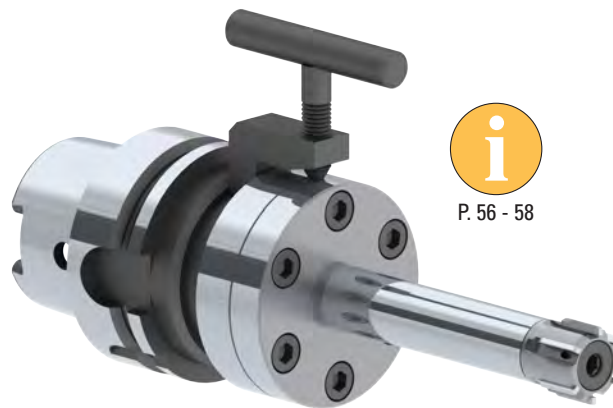

P. 56 - 58



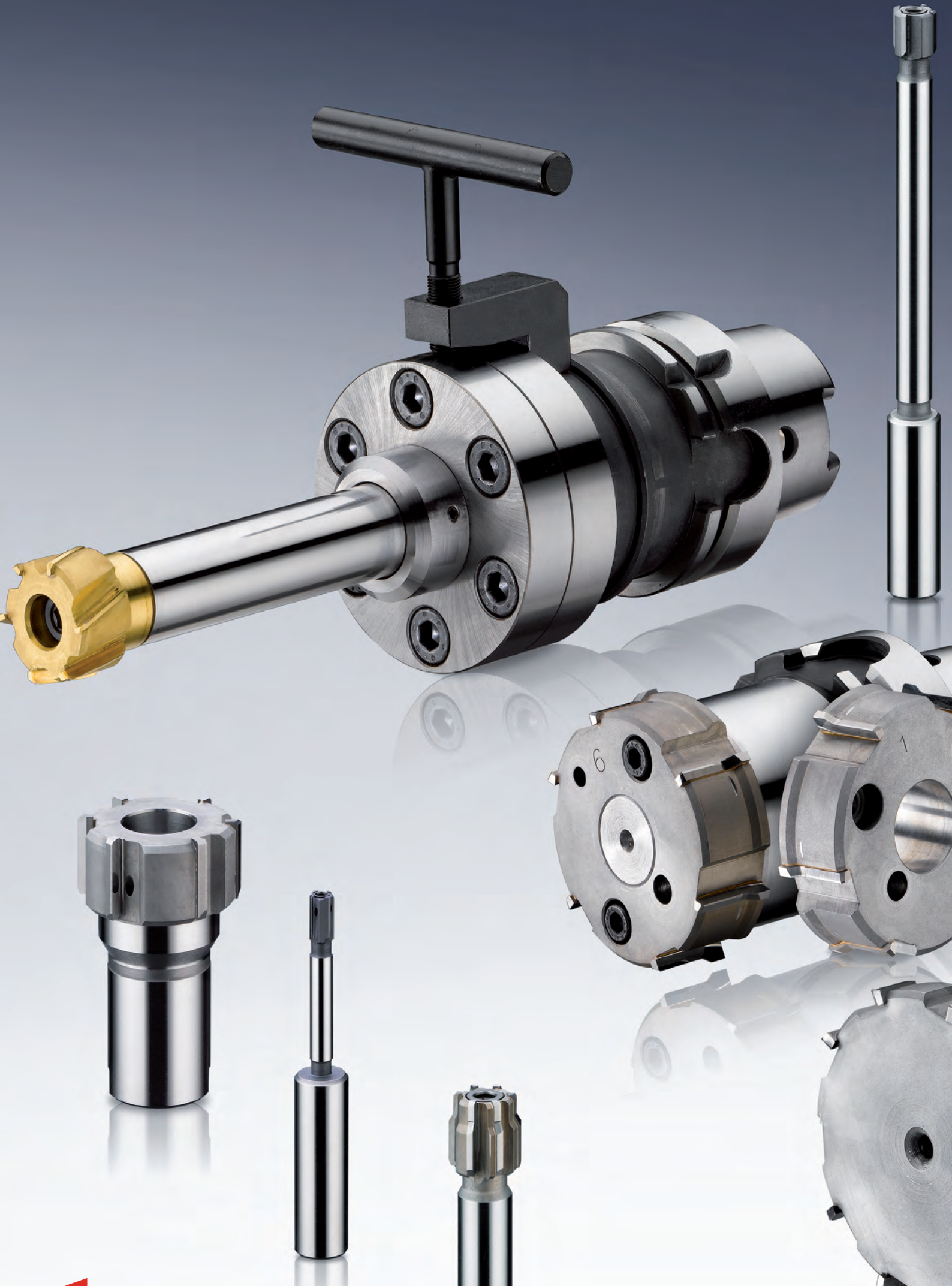

COMPENSATION HOLDERS & HOLDERS
PORTAHERRAMIENTAS DE COMPENSACIÓN
& *PORTAHERRAMIENTAS*
刀柄&补偿式刀柄



HYDRAULIC HOLDERS
MANDRINOS HIDRÁULICOS
可调式液压刀柄

53



ADAPTORS FOR MACHINES
ADAPTADORES PARA MÁQUINAS
机床刀柄

56

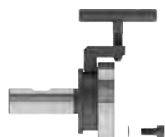

INTERMEDIARY ADAPTORS
ADAPTADORES INTERMEDIOS
中间连接单元

58



ADAPTORS FOR TOOLS
ADAPTADORES PARA HERRAMIENTAS
中间连接单元

59



ADAPTORS FOR ER COLLETS
ADAPTADORES PARA PINZAS ER
ER夹头连接单元

60



ADAPTORS FOR HEADS
ADAPTADORES PARA CABEZALES
连接单元用于铰削头

61

HOLDERS & ADAPTORS
ADAPTADORES & MANDRINOS
 机床刀柄

POLY 8154-HSK A



POLY 8154-ISO SK



POLY 8154-BT

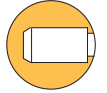

POLY 8254-HSK A

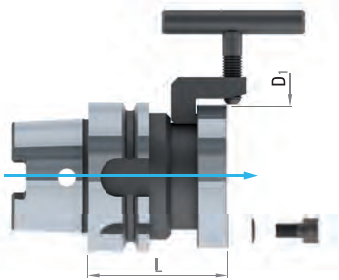

POLY 8354-ISO-SK

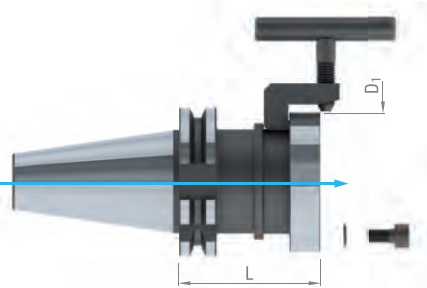

POLY 8354 BT

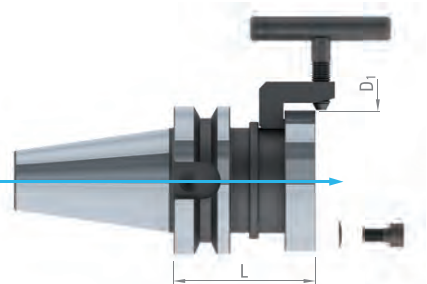

POLY 8054-DIN 1835 B

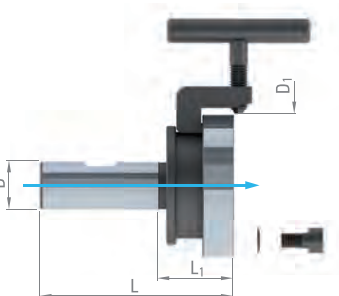

POLY 8524-DIN 1835 B

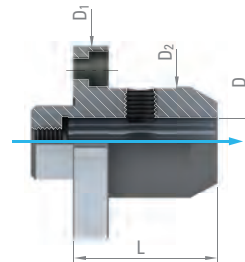

POLY 8524-ER

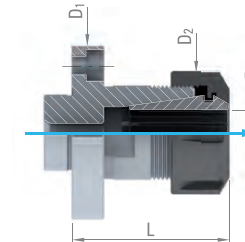

POLY 8502

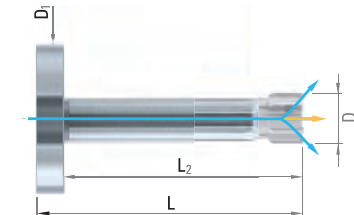

POLY 8154-HSK A

HYDRAULIC HOLDERS
 MANDRINOS HIDRÁULICOS
 液压刀柄

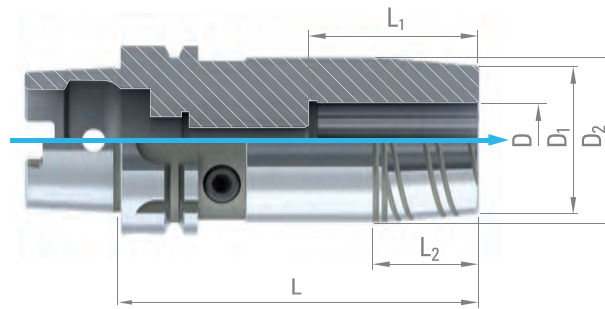

HSK A DIN 69893	D	L	L ₁	L ₂	D ₁	D ₂	Art.
40	12	80	46	-	32.0	34	345933
50	12	85	46	40	32.0	40	345934
50	16	90	49	46	38.0	42	345935
50	20	90	51	64	42.0	42	345936
63	12	85	46	40	32.0	50	345937
63	16	90	49	46	38.0	50	345938
63	20	90	51	46	42.0	50	345939
63	25	120	57	46	49.5	55	345940
63	32	125	61	99	56.0	63	345941
100	12	95	46	40	32.0	50	345942
100	16	100	49	46	38.0	50	345943
100	20	105	51	46	42.0	50	345944
100	25	115	57	86	49.5	55	345945
100	32	120	61	91	63.0	70	345946



POLY 8154-ISO SK

HYDRAULIC HOLDERS
 MANDRINOS HIDRÁULICOS
 液压刀柄

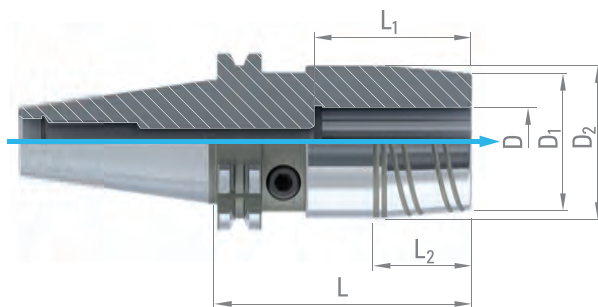

ISO-SK DIN 69871 AD	D	L	L ₁	L ₂	D ₁	D ₂	Art.
30	12	90	46	36	32.0	49.5	345947
30	20	100	57	46	42.0	49.5	345948
40	12	80	46	40	32.0	49.5	345949
40	16	80	49	46	38.0	49.5	345950
40	20	80	57	46	42.0	49.5	345951
40	25	95	57	76	49.5	55.0	345952
40	32	95	57	76	56.0	63.0	345953
50	12	80	46	40	32.0	49.5	345954
50	16	80	49	46	38.0	49.5	345955
50	20	80	57	46	42.0	49.5	345956
50	25	100	57	55	55.0	60.0	345957
50	32	100	57	55	63.0	70.0	345958

POLY 8154-BT

HYDRAULIC HOLDERS
 MANDRINOS HIDRÁULICOS
 液压刀柄

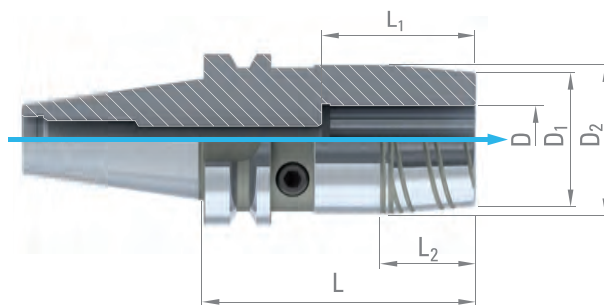

MAS-BT JIS B 6339	D	L	L ₁	L ₂	D ₁	D ₂	Art.
30	12	85	46	44.5	26.5	46	345959
30	20	90	51	44.5	36.0	40	345960
40	12	90	46	49.5	32.0	40	345961
40	16	90	49	49.5	38.0	46	345962
40	20	90	51	49.5	42.0	46	345963
40	25	90	57	55.0	49.5	63	345964
40	32	90	61	63.0	56.0	63	345965
50	12	110	46	49.5	32.0	40	345966
50	16	110	49	49.5	38.0	46	345967
50	20	110	51	49.5	42.0	46	345968
50	25	110	57	60.0	55.0	55	345969
50	32	115	61	70.0	63.0	55	345970

POLY 8254-HSK A

ADAPTORS FOR MACHINES
 ADAPTADORES PARA MÁQUINAS
 机床刀柄



P. 72

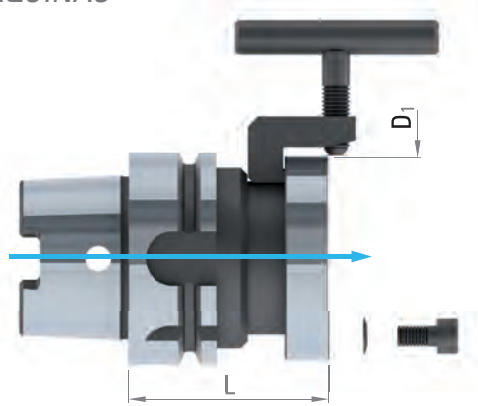

HSK A DIN 69893	D ₁	L	Art.
32	40	56	400922
40	40	58	401270
50	40	65	401271
63	40	65	401272
80	40	65	401273
100	40	68	401274
40	60	63	400923
50	50	70	400924
63	63	59	401285
80	80	70	401276
100	100	73	401277
50	50	74	400925
63	63	74	400926
80	80	74	401278
100	100	77	401279

Delivered with adjusting key, clamping screws and washers
 Suministrado con llave de reglaje, tornillos de fijación y arandelas
 交货包括调整螺丝扳手，夹紧螺丝和垫圈



POLY 8354-ISO SK

ADAPTORS FOR MACHINES
 ADAPTADORES PARA MÁQUINAS
 机床刀柄



P. 72

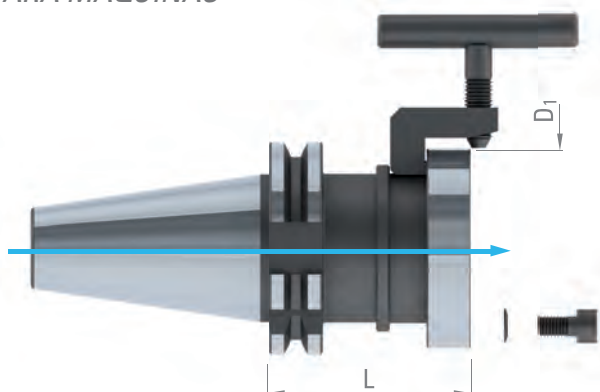

ISO-SK DIN 69871 AD	D ₁	L	Art.
40	40	58.0	400927
50	40	60.5	400928
40	60	63.0	400929
50	60	65.5	400930
40	71	67.0	400931
50	71	69.5	400932

POLY 8354-BT

ADAPTORS FOR MACHINES
 ADAPTADORES PARA MÁQUINAS
 机床刀柄



P. 72

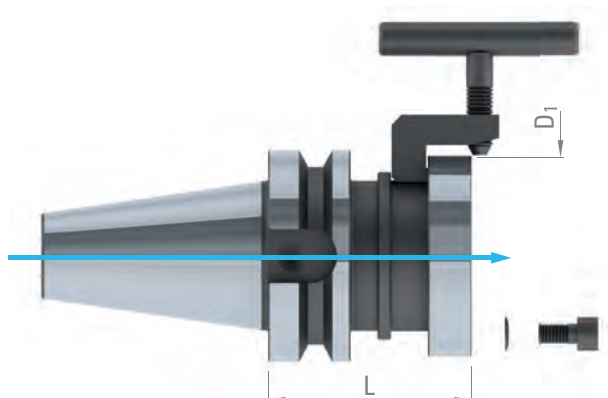

MAS-BT JIS B 6339	D ₁	L	Art.
40	60	53	64938
30	71	48	61490
40	71	65	61491
50	71	70	951465

Delivered with adjusting key, clamping screws and washers
 Suministrado con llave de reglaje, tornillos de fijación y arandelas
 交货包括调整螺丝扳手，夹紧螺丝和垫圈



POLY 8054-DIN 1835 B

INTERMEDIARY ADAPTORS
 ADAPTADORES INTERMEDIOS
 中间连接单元



P. 72

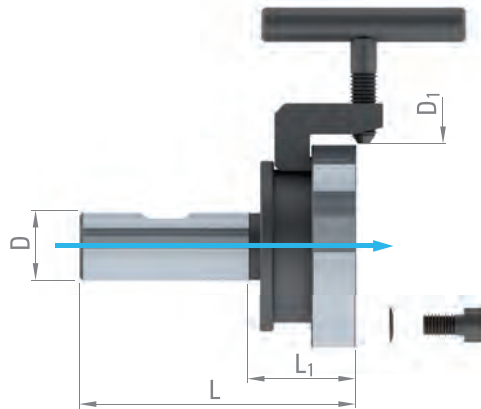

D_1	D_{h6}	L_1	L	Art.
40	12	21	68	400346
40	16	23	71	400347
60	20	28	81	400920
60	25	28	87	400921
71	20	34	90	400348
71	25	36	96	400349
71	32	37	100	400984
106	40	38	111	400351

Delivered with adjusting key, clamping screws and washers
 Suministrado con llave de reglaje, tornillos de fijación y arandelas
 交货包括调整螺丝扳手，夹紧螺丝和垫圈



POLY 8524-DIN 1835 B

ADAPTORS FOR TOOLS

ADAPTADORES PARA HERRAMIENTAS

中间连接单元



P. 72

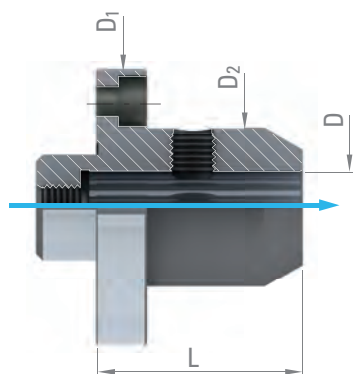

D_1	D_{h6}	D_2	L	Art.
40	8	20.0	42	400417
40	10	20.0	46	400418
60	10	30.0	36	400933
60	12	32.0	42	400934
60	16	34.5	45	400935
71	12	32.0	42	400419
71	16	35.0	44	400420
71	20	40.0	46	400421
71	25	50.0	70	400422
71	32	50.0	73	951431
106	32	64.0	77	951431

Delivered with clamping screws and washers

Suministrado con tornillos de fijación y arandelas

交货包括调整螺丝扳手，夹紧螺丝和垫圈



POLY 8524-ER

ADAPTORS FOR COLLETS
 ADAPTADORES PARA PINZAS
 夹头连接单元



P. 72

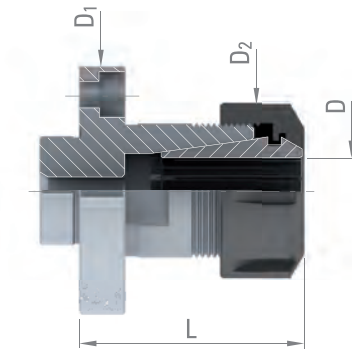

D ₁	ER	D	D ₂	L	Art.
40	16	1 - 10	22	40	400936
60	25	1 - 16	42	52	400938
71	32	2 - 20	50	63	400940

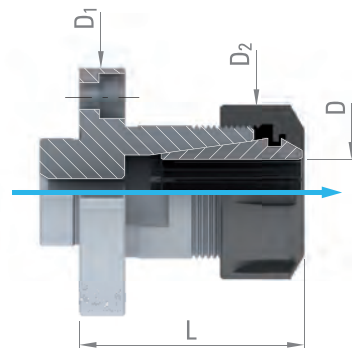

D ₁	ER	D	D ₂	L	Art.
40	16	1 - 10	22	44.0	400937
60	25	1 - 16	42	57.0	400939
71	32	2 - 20	50	65.5	400941

With nut for internal cooling, delivered without sealing washer
 Con tuerca para lubricación central, suministrado sin arandela de estanqueidad
 带内冷螺母，不带密封圈

Delivered without collet
 Suministrado sin pinza
 不带弹簧夹头



ADAPTORS FOR HEADS
 ADAPTADORES PARA CABEZALES
 连接单元用于铰削头



P. 72

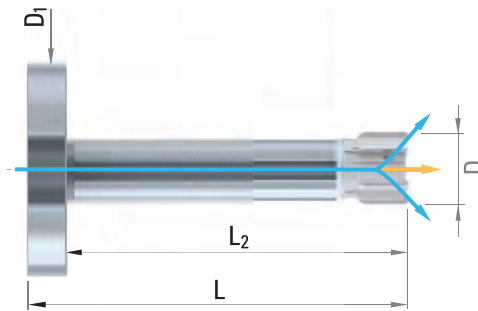

D	D ₁	L	L ₂	Art.
9.600 - 12.609	40	69	60	401222
12.610 - 15.609	40	84	75	401223
15.610 - 18.609	60	86	75	401224
18.610 - 23.109	60	106	95	401225
23.110 - 31.109	71	129	115	401226
31.110 - 45.000	71	134	120	401227
9.600 - 12.609	71	119	90	401228
12.610 - 15.609	71	129	100	401229
15.610 - 18.609	71	149	120	401230
18.610 - 23.109	71	169	140	401231
23.110 - 31.109	71	179	150	401232
31.110 - 45.000	71	179	150	401233

Order head & expansion or fixing screw separately (page 42-46)

Pedir por separado el cabezal & el tornillo de expansión o de fijación (pág. 42-46)

单独订购铰削头及其内涨式或者非内涨式螺丝 (42-46页)





Ver
? 0
12
f



CUTTING CONDITIONS
CONDICIONES DE CORTE
切削状况



SOLID CARBIDE REAMERS
ESCARIADORES CARBURO SÓLIDO
整体硬质合金

64



TIPPED REAMERS & HEADS
ESCARIADORES & CABEZALES
焊接式铰刀铰削头

66

CUTTING CONDITIONS SOLID CARBIDE REAMERS
CONDICIONES DE CORTE ESCARIADORES DE CARBURO SÓLIDO
切削状况



Materials to be machined

Materiales a mecanizar

被加工材料

Cutting speed

Velocidad de corte

切削速度

Vc [m/min]

			HM
P	Unalloyed steel / Low alloyed steel	< 600 N/mm ²	14
	<i>Acero no aleado / Acero de baja aleación</i>		16
	非合金钢/低合金钢		20
P	Unalloyed steel / Low alloyed steel	600 – 1500 N/mm ²	12
	<i>Acero no aleado / Acero de baja aleación</i>		14
	非合金钢/低合金钢		16
P	Lead alloyed cutting steel		25
	<i>Acero de decoletaje con plomo</i>		50
	鉛合金切削鋼 鉛合金切削鋼		70
P	High alloyed steel	700 – 1500 N/mm ²	8
	<i>Acero de alta aleación</i>		10
	高合金钢		12
M	Stainless steel	400 – 700 N/mm ²	10
	<i>Acero inoxidable</i>		12
	不锈钢		16
M	DUPLEX stainless steel	> 800 N/mm ²	8
	<i>Acero inox. DUPLEX, acero inox. austenítico sin nickel</i>		10
	双相不锈钢		12
K	Grey cast iron / Nodular pearlitic iron	< 250 HB	20
	<i>Fundición gris / Fundición de grafito esférico perlítica</i>		30
	灰口铸铁/球墨珠光体铸铁		40
K	Alloyed cast iron / Nodular pearlitic iron	> 250 HB	12
	<i>Fundición aleada / Fundición de grafito esférico perlítica</i>		18
	合金铸铁/球墨珠光体铸铁		24
K	Nodular ferritic cast iron / Malleable cast iron		14
	<i>Fundición de grafito esférico ferrítico / Fundición maleable</i>		20
	球墨铁素体铸铁/可锻铸铁		32
S	Special alloys / Heat resistant stainless steel	Inconel	8
	<i>Superaleaciones / Acero inox. refractario</i>	Nimonic	10
	特殊合金/耐热不锈钢	Hastelloy	12
S	Titanium, titanium alloys		10
	<i>Titanio / Aleaciones de titanio</i>		12
	钛, 钛合金		16
N	Copper alloys - easy to machine (brass - bronze)		20
	<i>Aleaciones de cobre - fácil de mecanizar (latón y bronce)</i>		30
	铜合金-易加工 (黄铜-青铜)		40
N	Copper alloys - difficult to machine / Aluminium bronze	(CuAlFe)	16
	<i>Aleaciones de cobre - difícil de mecanizar / Bronce de aluminio</i>	(Ampco)	24
	铜合金-难加工/铝青铜		30
N	Aluminium alloys	Si < 8%	20
	<i>Aleación de aluminio</i>		40
	铝合金		60
N	Cast aluminium	Si > 8%	20
	<i>Fundición de aluminio</i>		36
	铸铝		50
N	Plastic		20
	<i>Plástico</i>		40
	塑料		60
N	Plastic with fibres		10
	<i>Plástico con fibras</i>		20
	塑料纤维		30
N	Gold, silver		20
	<i>Oro / Plata</i>		30
	金, 银		40

$$n \text{ [tr/min]} = \frac{Vc \text{ [m/min]} \times 1000}{\pi \times D_1 \text{ [mm]}}$$

$$Vf \text{ [mm/min]} = n \text{ [tr/min]} \times f \text{ [mm]}$$

Feed per revolution
Avance por vuelta
每转进给量 **f [mm]**

$\emptyset D_1$ < 2.00	$\emptyset D_1$ 2.00 - 4.03	$\emptyset D_1$ 4.03 - 7.51	$\emptyset D_1$ 7.51 - 12.02
0.05	0.10	0.30	0.40
0.15	0.20	0.50	0.60
0.20	0.30	0.70	0.80
0.05	0.10	0.25	0.30
0.15	0.20	0.40	0.50
0.20	0.30	0.65	0.70
0.05	0.20	0.40	0.60
0.15	0.40	0.60	0.80
0.20	0.50	0.80	1.00
0.05	0.10	0.20	0.30
0.15	0.15	0.30	0.40
0.20	0.25	0.40	0.50
0.05	0.10	0.20	0.30
0.15	0.15	0.30	0.40
0.20	0.20	0.40	0.50
0.05	0.10	0.20	0.30
0.15	0.15	0.30	0.40
0.20	0.25	0.40	0.50
0.05	0.10	0.40	0.60
0.15	0.15	0.50	0.70
0.20	0.25	0.60	0.80
0.05	0.10	0.30	0.40
0.15	0.15	0.40	0.50
0.20	0.20	0.50	0.60
0.05	0.10	0.30	0.40
0.15	0.20	0.40	0.50
0.20	0.30	0.50	0.60
0.05	0.10	0.20	0.30
0.15	0.15	0.30	0.40
0.20	0.20	0.40	0.50
0.05	0.10	0.20	0.30
0.15	0.15	0.30	0.40
0.20	0.20	0.40	0.50
0.05	0.10	0.30	0.40
0.15	0.20	0.40	0.50
0.20	0.30	0.50	0.60
0.05	0.10	0.40	0.60
0.20	0.25	0.60	0.80
0.30	0.40	0.80	1.00
0.05	0.10	0.40	0.60
0.20	0.25	0.60	0.80
0.30	0.40	0.80	1.00
0.05	0.10	0.40	0.50
0.20	0.25	0.50	0.60
0.30	0.40	0.60	0.70
0.05	0.10	0.30	0.40
0.20	0.25	0.40	0.50
0.30	0.40	0.50	0.60
0.05	0.10	0.40	0.60
0.15	0.20	0.60	0.80
0.20	0.30	0.80	1.00

0.05	0.10	0.10	0.10	Reaming allowance (Stock material)
0.10	0.15	0.15	0.15	<i>Sobremedida</i> \emptyset [mm]
0.15	0.20	0.20	0.20	铰削余量



CUTTING CONDITIONS TIPPED REAMERS & HEADS
CONDICIONES DE CORTE ESCARIADORES & CABEZALES
切削状况



Materials to be machined

Materiales a mecanizar

被加工材料

		DIN	W. Nr.	Rm	HB / HRC
P	Unalloyed steel / Low alloyed steel <i>Acero no aleado / Acero de baja aleación</i> 非合金钢/低合金钢	St37-2 / S235JR	1.0037	< 600 N/mm ²	
		9SMn28 / 11SMn30	1.0715		
		St52-2 / E295	1.0050		
		9SMnPb28 / 11SMnPb30	1.0718		
P	Unalloyed steel / Low alloyed steel <i>Acero no aleado / Acero de baja aleación</i> 非合金钢/低合金钢	42CrMo4	1.7225	600 – 1500 N/mm ²	
		CK60 / C60E	1.1221		
P	High alloyed steel <i>Acero de alta aleación</i> 高合金钢/不锈钢	X6CrMo4 / 6CrMo15-5 X165Cr-MoV12	1.2341 1.2601	700 – 1500 N/mm ²	
M	Stainless steel <i>Acero inoxidable</i> 不锈钢, 耐热钢	X2CrNi189 / X2CrNi19-11	1.4306	400 – 700 N/mm ²	
		Mo1810 / X5CrNiMo17-12-2	1.4401		
		X2CrNiMo18-14-3 / 316L	1.4435		
		X8CrNb17 / X3CrNb17	1.4511		
M	DUPLEX stainless steel <i>Acero inox. DUPLEX, acero inox. austenítico sin nickel</i> 双相不锈钢	X10CrAIS17 X8CrS-38-18	1.4713 1.4862	> 800 N/mm ²	
H	Hardened steels <i>Aceros templados</i> 淬硬钢			> 1500 N/mm ²	45 - 65 HRC
K	Grey cast iron <i>Fundición gris</i> 灰口铸铁	GG-25 / EN-GJL-250	0.6025		< 250 HB
		GG-35 / EN-GJL-350	0.6035		
K	Alloyed grey cast iron <i>Fundición gris aleada</i> 合金灰口铸铁	GG-NiCr202 / GJL-NiCr20-2	0.6660		> 250 HB
K	Spheroidal graphite cast iron ferritic / perlitic <i>Fundición de grafito esferoidal ferrítico / perlítica</i> 球墨铸铁 铁素体/珠光体	GGG-40 / EN-GJS-400-15	0.7040		< 600 HB
		GGG-50 / GGG-55	0.7050		
		GTW-55	0.8055		
K	Spheroidal graphite cast iron / Perlitic malleable iron <i>Fundición de grafito esferoidal ferrítico / Fundición perlítica maleable</i> 球墨铸铁/珠光体马氏体	GGG-60 / EN-GJS-600-3 GTS-65	0.7060 0.8165		> 600 HB
K	Alloyed spheroidal graphite cast iron / Vermicular cast <i>Fundición de grafito esferoidal / Fundición vermicular</i> 合金球墨铸铁/蠕墨铸铁	GGG NiCr20-2 GGV Ti <0.2 GGV Ti >0.2	0.7661		
S	Special alloys / Heat resistant stainless steel <i>Superalaciones / Acero inox. refractario</i> 特殊合金/耐热不锈钢	Inconel Nimonic Hastelloy		> 1500 N/mm ²	
S	Titanium / Titanium alloys <i>Titanio / Aleaciones de titanio</i> 钛, 钛合金	TiAl55n2	3.7114		
N	Copper alloy (brass - bronze) <i>Aleaciones de cobre (latón y bronce)</i> 铜合金	CuZn36Pb3	2.1182		
		G-CuPb15Sn	2.1182		
N	Copper alloy / Aluminium bronze <i>Aleaciones de cobre / Bronce de aluminio</i> 铜合金/铜铝合金	CuZn40Al1 E-Cu57	2.0550 2.0060		
N	Cast aluminium alloy <8 % Si / Magnesium alloy <i>Aleación de aluminio <8 % Si / Aleación de magnesio</i> 铸铝合金<8 % 硅 / 镁合金	G-ALMg5	3.3561		
N	Cast aluminium alloy >8 % Si <i>Aleación de aluminio >8 % Si</i> 铸铝合金>8 % 硅	G-AISi9Mg	3.2373		
		G-AISi10Mg	3.2381		

$$n \text{ [tr/min]} = \frac{Vc \text{ [m/min]} \times 1000}{\pi \times D_1 \text{ [mm]}}$$

$$Vf \text{ [mm/min]} = n \text{ [tr/min]} \times f \text{ [mm]}$$

Cutting speed <i>Velocidad de corte</i> 切削速度						Feed per revolution <i>Avance por vuelta</i> 每转进给量			
Vc [m/min]						f [mm]			
HM	TiAlN	POLY-CUT	C-TOP	DLC	CERMET	Ø D ₁ 5.80 - 10.60	Ø D ₁ 10.70 - 18.60	Ø D ₁ 18.70 - 44.90	Ø D ₁ 45 - 120
25	60	60			100	0.20	0.40	0.60	0.80
30	90	90			130	0.30	0.50	0.70	0.90
35	120	120			150	0.50	0.70	0.90	1.10
20	60	60	30		80	0.20	0.40	0.60	0.80
25	80	80	40		100	0.30	0.50	0.70	0.90
30	100	100	50		120	0.50	0.70	0.90	1.10
15	30	30	30			0.15	0.25	0.35	0.45
20	40	40	40			0.20	0.30	0.40	0.50
25	50	50	50			0.30	0.40	0.50	0.60
15	30	30	30			0.20	0.30	0.40	0.50
20	40	40	40			0.30	0.40	0.50	0.60
25	50	50	50			0.40	0.50	0.60	0.70
10	30	30	30			0.20	0.30	0.40	0.50
15	40	40	40			0.30	0.40	0.50	0.60
20	50	50	50			0.40	0.50	0.60	0.70
			10			0.10	0.15	0.20	0.25
			15			0.15	0.20	0.25	0.30
			20			0.20	0.25	0.30	0.35
20	90	90				0.30	0.50	0.70	0.90
30	120	120				0.40	0.60	0.80	1.00
40	140	140				0.50	0.70	0.90	1.10
12	90	90				0.20	0.40	0.60	0.80
18	120	120				0.30	0.50	0.70	0.90
24	140	140				0.50	0.70	0.90	1.10
12	90	90			110	0.30	0.50	0.70	0.90
18	120	120			140	0.40	0.60	0.80	1.00
24	140	140			160	0.50	0.70	0.90	1.10
14	90	90			100	0.20	0.40	0.60	0.80
20	120	120			120	0.30	0.50	0.70	0.90
32	140	140			140	0.40	0.60	0.80	1.00
12	50	50				0.20	0.30	0.40	0.50
18	60	60				0.30	0.40	0.50	0.60
24	80	80				0.40	0.50	0.60	0.70
	10	10				0.15	0.20	0.30	0.45
	15	15				0.20	0.25	0.35	0.50
	20	20				0.30	0.30	0.40	0.60
10						0.20	0.30	0.40	0.50
15						0.30	0.40	0.50	0.60
20						0.40	0.50	0.60	0.70
30	100	100		80		0.30	0.50	0.70	0.90
40	120	120		120		0.40	0.60	0.80	1.00
50	150	150		160		0.50	0.70	0.90	1.10
25	60	60		80		0.20	0.40	0.60	0.80
30	80	80		120		0.30	0.50	0.70	0.90
35	100	100		160		0.40	0.60	0.80	1.00
30				250		0.30	0.50	0.70	0.90
50				200		0.40	0.60	0.80	1.00
70				300		0.50	0.70	0.90	1.10
30				150		0.30	0.50	0.70	0.90
40				200		0.40	0.60	0.80	1.00
50				300		0.50	0.70	0.90	1.10

Reaming allowance (Stock material)	0.10	0.15	0.15	0.20
<i>Sobremedida</i> Ø [mm]	0.15	0.20	0.20	0.30
铰削余量	0.20	0.30	0.30	0.40







RETIPPING
REGENERACIÓN
重磨

71



RADIAL COMPENSATION HOLDERS
MANDRINO DE COMPENSACIÓN RADIAL
径向补偿式刀柄

72

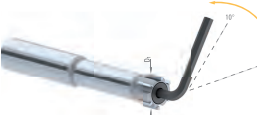

EXPANDABLE SYSTEM TECHNOLOGY
TECNOLOGÍA DE SISTEMA EXPANSIBLE
内涨技术

73

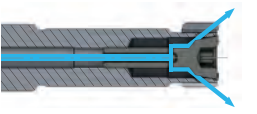

COOLING TECHNOLOGY
TECNOLOGÍA DE REFRIGERACIÓN
冷却技术

74



REAMERS WITH GUIDES TECHNOLOGY
TECNOLOGÍA ESCARIADORES CON GUÍA
带导条铰刀

75

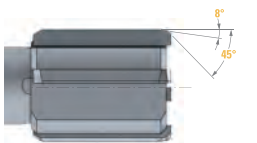

CUTTING GEOMETRY
GEOMETRÍA DE CORTE
切削几何角度

76



RETIPPING

REGENERACIÓN

重磨

Retipping

Depending on tool wear, DIXI Polytool's retipping center offers a complete change of inserts.
Retipping is possible with CARBIDE and CERMET inserts.

The retipping is ensured for the tools of all manufacturers.

Regeneración

Según el desgaste de la herramienta, el centro de regenerado de DIXI Polytool les propondrà un cambio completo de insertos.

La regeneración es posible mediante plaquitas de CARBURO y de CERMET.

Se asegura el regenerado para las herramientas de todos los fabricantes.

铰刀重磨的好处

我们根据铰刀的磨损状况，在我们车间进行重磨。

我们也可以重磨和金属陶瓷铰刀。

我们修磨其他品牌的铰刀。

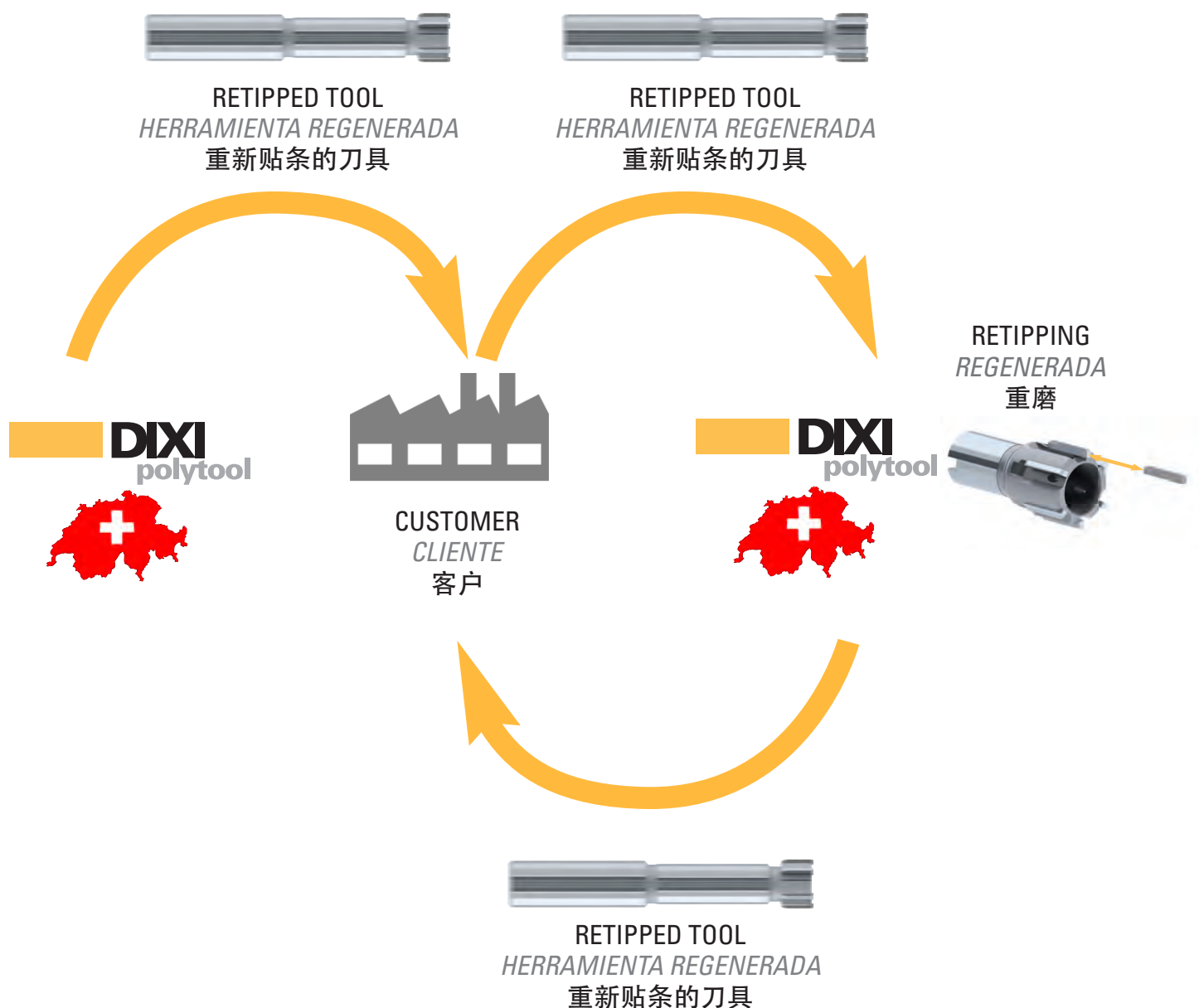

RADIAL COMPENSATION HOLDERS

MANDRINO DE COMPENSACIÓN RADIAL

径向补偿式刀柄



1. Assemble the reamer (drill, center drill, etc.) with the compensation holder.
2. Mount the compensation holder on the machine spindle.
3. Release the screws (2) and put them under tension, one after the other (spring washer compression).
4. Position the comparator on the ground part of the tool behind the teeth (see figure).
5. Insert the adjusting key (1) where the coaxiality error is the highest and tighten it till the comparator indicates half of the error. Release the key.
6. Check the coaxiality. If necessary, repeat the procedure (if there is enough space, it is not necessary to remove the key as it is possible to turn it in the groove).
7. Tighten the screws crosswise (2).
8. Remove the key (1).

1. Montar el escariador (broca, broca para centrar, etc) con el mandrino de compensación.
2. Montar el portaherramienta en el mandrino de la máquina.
3. Aflojar los tornillos (2) y ponerlos bajo tensión uno después del otro (compensación de las arandelas grower).
4. Colocar el comparador en la parte rectificada de la herramienta lo más próximo de los dientes (ver figura).
5. Insertar la llave de reglaje (1) donde el error de coaxialidad sea más alto y apretar hasta que el comparador indique la mitad del error. Soltar la llave.
6. Controlar la coaxialidad. Si fuera necesario, repetir el procedimiento. Si hay suficiente espacio y no es necesario retirar la llave, es posible hacerla girar en la ranura.
7. Apretar los tornillos transversalmente (2).
8. Retirar la llave (1).

1. 用补偿式刀柄夹持铰刀（钻头，中心钻等）
2. 把补偿式刀柄安装在机床主轴上
3. 松开螺丝（2），然后一个接一个拧紧它们（弹簧垫片压紧）
4. 把探针放在刀齿下面磨制过的刀杆上（看图片）
5. 把调整块放在跳动最大的部位，拧紧它，直到跳动降到一半。松开调整块。
6. 检查跳动。如有必要，重复操作（如果有足够的空间，没有必要拿走调整块既然它还有可能进入键槽里
7. 拧紧对角线上的螺丝（2）。
8. 拿走调整块（1）

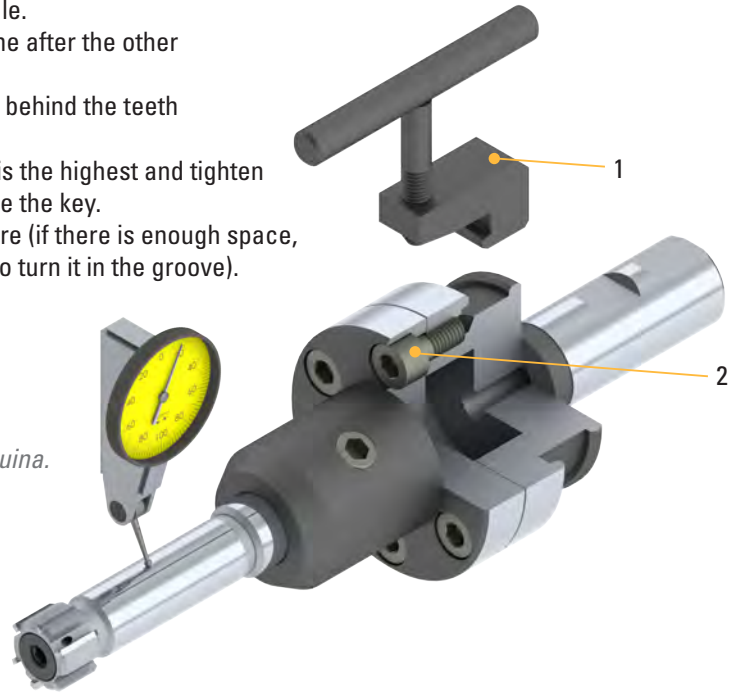

TOLERANCE SYSTEM
SISTEMA DE TOLERANCIA
公差体系

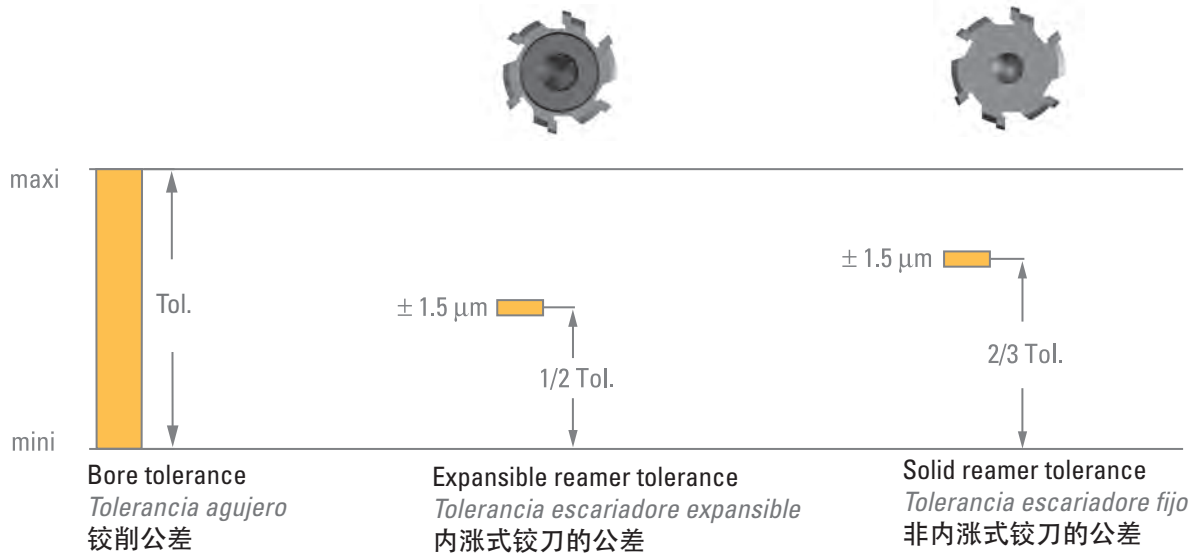

EXPANDABLE SYSTEM TECHNOLOGY
TECNOLOGÍA DE SISTEMA EXPANDIBLE
内涨技术

Setting the $\emptyset D_1$ - elasticity zone \approx de $+10^\circ$ à $+40^\circ$
Ajuste del $\emptyset D_1$ zona elástica \approx de $+10^\circ$ a $+40^\circ$
 $\emptyset D_1$ 的弹性调整区域从 $+10^\circ$ 到 $+40^\circ$

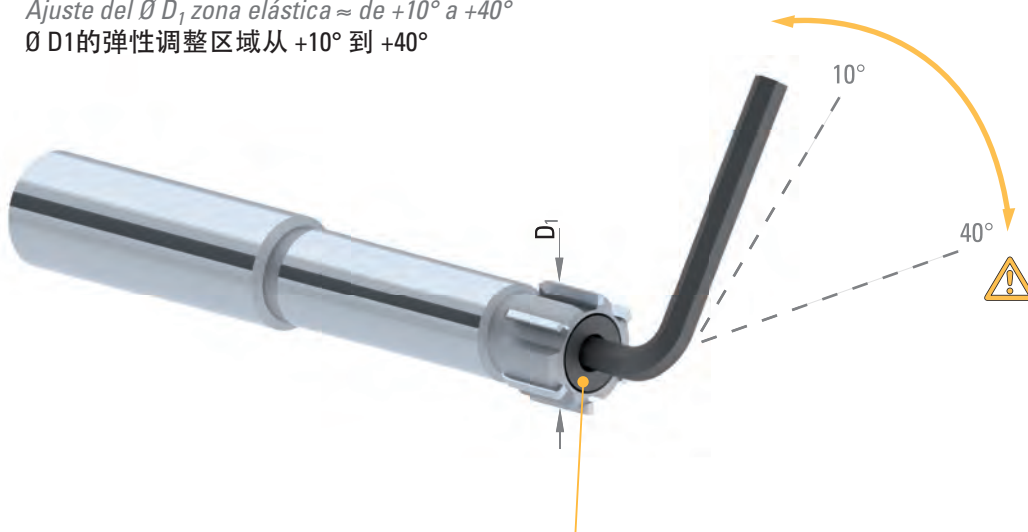

Head Cabeza 铰削头	D_1	Screw Tornillo 螺丝	Expandable Expansible 内涨式
	5.80 - 9.60	M ... x 0.35	$+10^\circ = D1 + 0.0025$
	9.61 - 21.10	M ... x 0.50	$+10^\circ = D1 + 0.0035$
	21.11 - 55.00	M ... x 0.75	$+10^\circ = D1 + 0.0050$





TC Cooling system
TC Refrigeración
TC 冷却方式

POLY 4361-TC

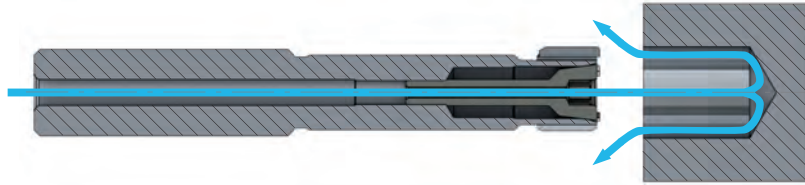

Advantages of the **TC cooling system** for blind holes:

- Returning liquid ejects the chips backwards
- The hole is cleaned before the reaming operation

Ventajas del sistema de TC refrigeración para agujeros ciegos:

- El regreso del líquido empuja las virutas hacia atrás
- El agujero se limpia antes de la operación de escariado

冷却方式TC对于盲孔加工的优势:

- 把铁屑从孔底冲走
- 在铰削之前，孔内已经被清洗干净

FC Cooling system
FC Refrigeración
FC 冷却方式

POLY 4361-FC

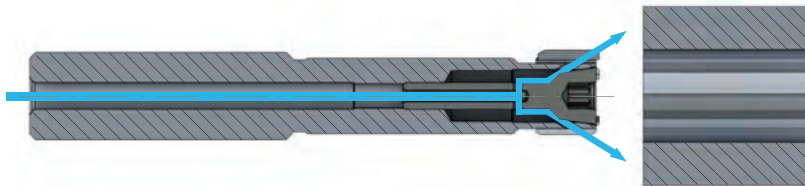

Advantages of the **FC cooling system** for through holes:

- Precise watering of the cutting edge

Ventajas del sistema de FC refrigeración para agujeros pasantes:

- Riego preciso del tope de corte

冷却方式FC的优点:

- 可以精确地对切削部位进行冷却





Fig.1

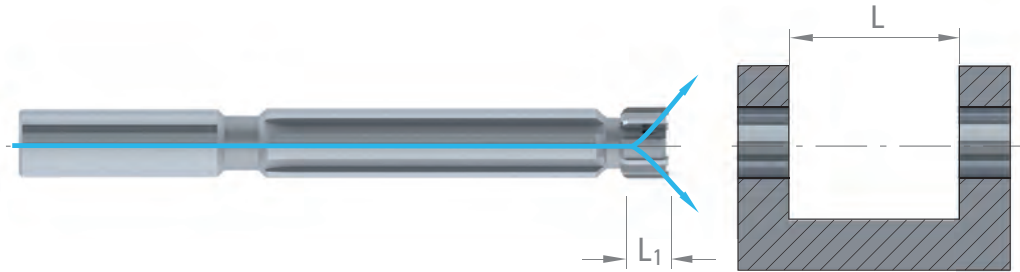

Fig.2

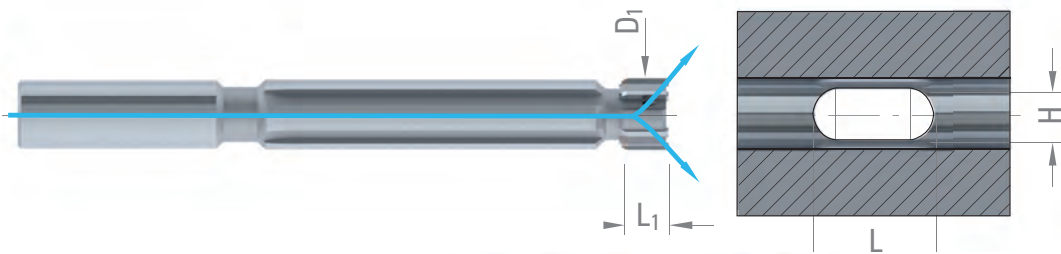
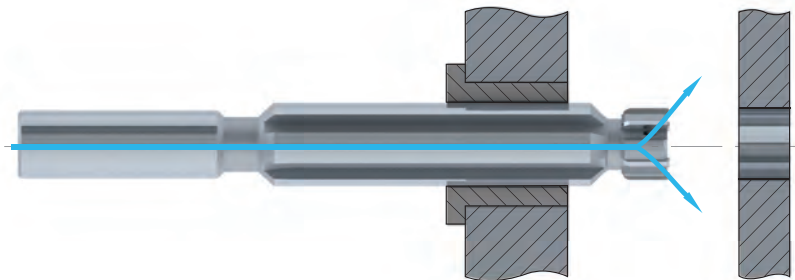

Fig.3



Application of reamers with guides

The guide diameter is generally 15 to 20 μm smaller than the reaming diameter.
The coolant must be abundant to evacuate the chips and to lubricate the guides.

Aplicaciones de los escariadores con guía

El diámetro de la guía es generalmente de 15 a 20 μm menor que el diámetro del escariado.
La refrigeración debe ser abundante para expulsar las virutas y lubricar la guía.

带导条铰刀的应用

导条直径一般小于铰刀直径15至20微米。
冷却液必须充足，以排除铁屑及润滑导条。



CUTTING GEOMETRY
 GEOMETRÍA DE CORTE
 切削几何角度

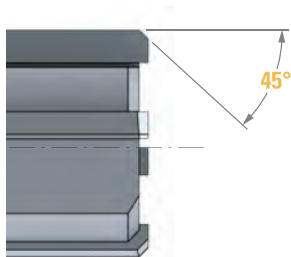

Standard cut 45°
 Corte standard 45°
 标准倒角 45°

- ✓ Standard bore
 Escariado estándar
 标准孔

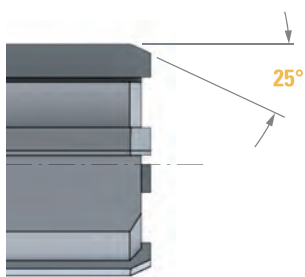

Flat cut 25°
 Corte plano 25°
 倒角 25°

- ✓ High feedrate ($V_c ; f + 50\%$), increased tool life
 Alta velocidad de avance ($V_c ; f + 50\%$), mayor vida útil
 高进给 ($V_c ; f + 50\%$), 增加刀具寿命

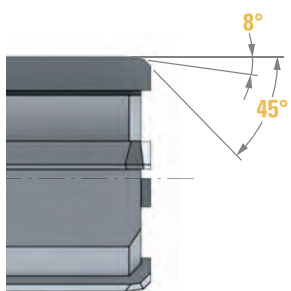

Double angle cut 45°/8°
 Corte doble ángulo 45°/8°
 双导向角 45°/8°

- ✓ Better surface finish
 Mejor acabado superficial
 更好的表面精度

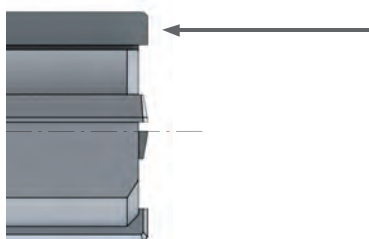

Front cut
 Corte frontal
 端面切削

- ✓ Reamer/piece position error
 Error de posición del escariador/pieza
 铰刀/工件的位置精度

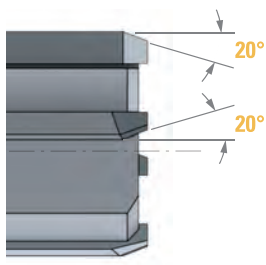

Negative cut 20°/20°
 Corte negativo 20°/20°
 负型切削 20°/20°

- ✓ Chip evacuation forward
 Evacuación de viruta hacia adelante
 向前排屑

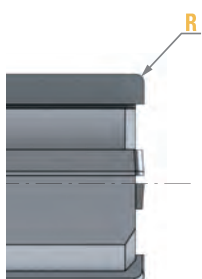

Radius cut
 Corte con radio
 圆角

- ✓ Shape geometry
 Geometría de forma
 几何形状

DIXI POLYTOOL S.A.R.L
ZAC de Rubellin
FR-73730 Cevins
T +33 (0)4 79 38 25 92
F +33 (0)4 79 38 26 65
dixifrance@dixi.com

DIXI POLYTOOL GmbH
Carl-Benz-Str. 11
DE-75217 Birkenfeld
T +49 (0)7231-1 68 98-0
F +49 (0)7231-3 39 19
dixipolytool@dixi.com

DIXI POLYTOOL B.V.
De Hofstede 11
NL-4033 BT Lienden
T +31 (0)344-603410
F +31 (0)344-603488
dixiholland@dixi.com

DIXI POLYTOOL SPAIN S.L.
Bailen 141 Esc. Dr, Entl. 5a
ES-08037 Barcelona
T +34 678 917 351
dixispain@dixi.com

DIXI POLYTOOL S.A. / VENTURA MECANICS S.A.
中国（上海）自由贸易区富特东三路526号上海
瑞士中心3号楼A301室，200131
Swiss Center Shanghai Machinery and Trading
and Business Center Room A208, Building 3, NO.
526, 3rd East Fute Road
200131 China (Shanghai) Pilot Free Trade Zone

polytool



GENERAL MECHANICS
MECÁNICA GENERAL
通用机械



HYDRAULIC
HIDRÁULICA
液压

AUTOMOTIVE
AUTOMOCIÓN
汽车

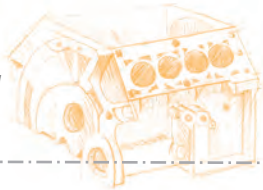

AERONAUTICS
AERONÁUTICA
航空航天

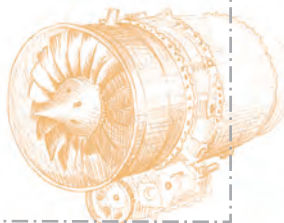

ENERGY
ENERGÍA
能源



TURNING SCREW
CUTTING
DECOLETAJE
瑞士型车床



MICROMECHANICS/ELECTRONICS
MICROMÉCANICA/ELECTRONICA
微机械/电子

LORRY
CAMIÓN
卡车



 **DIXI**
polytool

DIXI POLYTOOL S.A.

Av. du Technicum 37
CH-2400 Le Locle

T +41 (0)32 933 54 44

F +41 (0)32 931 89 16

dixipoly@dixi.ch

www.dixipolytool.com

