

T- GLEUFFREZEN

- Korte levertijden
- Basismateriaal op voorraad
- Diverse geometrieën en vertandingen



T-Gleuffrezen
op aanvraag
Ø 2 - 30 mm

DIXI 1525

T- GLEUFFREZEN MET RECHTE VERTANDING

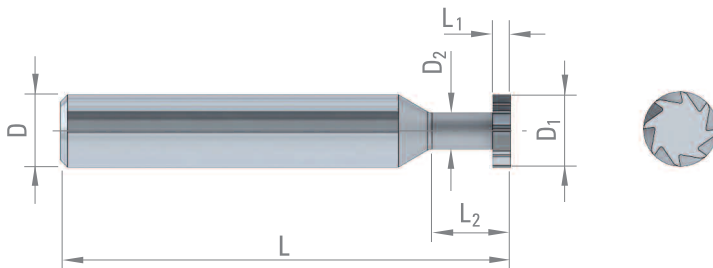

Steel + Pb	Low alloyed steel	DUPLEX stainless steel	Titanium, titanium alloy	Cu alloy Silver Gold
Al	Plastic			

D ₁ Ø < 4.0 ±0.01 Ø ≥ 4.0 -0.05/-0.10	L ₁	D ₂ 0/-0.20	L ₂ ±0.2	D _{h6}	L	Z	CARBIDE	CUTINOX
2.0	0.2 - 1.0	1.0	3.0	4	42	3 - 6	<input type="checkbox"/>	<input checked="" type="checkbox"/>
3.0	0.2 - 1.5	1.5	3.5	4	42	3 - 6	<input type="checkbox"/>	<input checked="" type="checkbox"/>
4.0	0.2 - 1.5	2.5	6.0	4	42	3 - 6	<input type="checkbox"/>	<input checked="" type="checkbox"/>
5.0	0.5 - 1.5	3.0	6.0	5	42	3 - 6	<input type="checkbox"/>	<input checked="" type="checkbox"/>
6.0	0.5 - 2.5	3.5	7.0	6	42	4 - 8	<input type="checkbox"/>	<input checked="" type="checkbox"/>
8.0	0.5 - 3.0	4.0	9.0	8	50	5 - 10	<input type="checkbox"/>	<input checked="" type="checkbox"/>
10.0	0.5 - 4.0	5.0	9.0	10	50	5 - 12	<input type="checkbox"/>	<input checked="" type="checkbox"/>
12.0	0.5 - 3.5	5.0	11.5	6	50	6 - 16	<input type="checkbox"/>	<input checked="" type="checkbox"/>
12.0	0.5 - 4.0	6.0	14.0	10	50	6 - 16	<input type="checkbox"/>	<input checked="" type="checkbox"/>
15.0	0.5 - 5.0	8.0	14.0	10	60	8 - 18	<input type="checkbox"/>	<input checked="" type="checkbox"/>
16.0	0.5 - 2.9	8.0	14.0	10	60	8 - 20	<input type="checkbox"/>	<input checked="" type="checkbox"/>
16.0	3.0 - 6.0	8.0	14.0	10	60	8 - 20	<input type="checkbox"/>	<input checked="" type="checkbox"/>
18.0	0.5 - 2.9	8.0	14.0	10	60	10 - 24	<input type="checkbox"/>	<input checked="" type="checkbox"/>
18.0	3.0 - 6.0	8.0	14.0	10	60	10 - 24	<input type="checkbox"/>	<input checked="" type="checkbox"/>
20.0	0.5 - 2.9	8.0	11.0	10	60	10 - 24	<input type="checkbox"/>	<input checked="" type="checkbox"/>
20.0	3.0 - 6.0	8.0	14.0	10	60	10 - 24	<input type="checkbox"/>	<input checked="" type="checkbox"/>
25.0	0.5 - 3.9	8.0	13.0	10	60	10 - 32	<input type="checkbox"/>	<input checked="" type="checkbox"/>
25.0	4.0 - 8.0	8.0	18.0	10	60	10 - 32	<input type="checkbox"/>	<input checked="" type="checkbox"/>
30.0	0.5 - 3.9	8.0	13.0	10	60	10 - 36	<input type="checkbox"/>	<input checked="" type="checkbox"/>
30.0	4.0 - 8.0	8.0	18.0	10	60	10 - 36	<input type="checkbox"/>	<input checked="" type="checkbox"/>

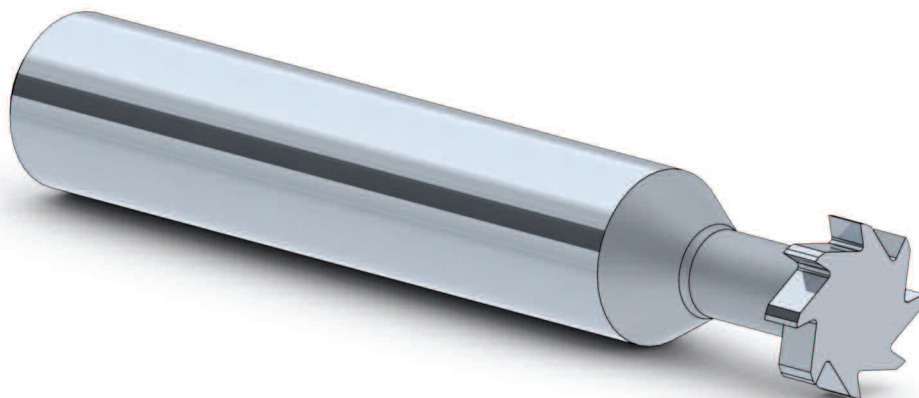

DIXI 1528

T- GLEUFFREZEN MET KRUISVERTANDING

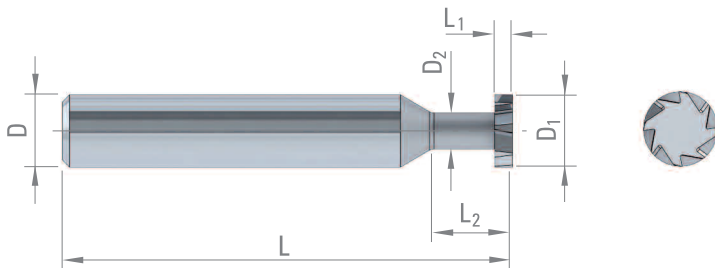

Steel + Pb	Low alloyed steel	DUPLEX stainless steel	Titanium, titanium alloy	Cu alloy Silver Gold
Al	Plastic			

D ₁ Ø < 4.0 ±0.01 Ø ≥ 4.0 -0.05/-0.10	L ₁	D ₂ 0/-0.20	L ₂ ±0.2	D _{h6}	L	Z	CARBIDE	CUTINOX
4.0	0.5 - 3.0	2.5	6.0	4	42	4 - 6	<input type="checkbox"/>	<input checked="" type="checkbox"/>
5.0	0.5 - 3.0	3.0	6.0	5	42	4 - 6	<input type="checkbox"/>	<input checked="" type="checkbox"/>
6.0	0.5 - 3.0	3.5	7.0	6	42	4 - 6	<input type="checkbox"/>	<input checked="" type="checkbox"/>
8.0	1.0 - 4.0	4.0	9.0	8	50	4 - 8	<input type="checkbox"/>	<input checked="" type="checkbox"/>
10.0	1.0 - 4.0	5.0	9.0	10	50	6 - 10	<input type="checkbox"/>	<input checked="" type="checkbox"/>
12.0	0.5 - 3.5	5.0	11.5	6	50	6 - 10	<input type="checkbox"/>	<input checked="" type="checkbox"/>
12.0	1.0 - 5.0	6.0	14.0	10	50	6 - 10	<input type="checkbox"/>	<input checked="" type="checkbox"/>
15.0	1.5 - 6.0	8.0	14.0	10	60	8 - 14	<input type="checkbox"/>	<input checked="" type="checkbox"/>
16.0	1.5 - 3.9	8.0	14.0	10	60	8 - 14	<input type="checkbox"/>	<input checked="" type="checkbox"/>
16.0	4.0 - 6.0	8.0	14.0	10	60	8 - 14	<input type="checkbox"/>	<input checked="" type="checkbox"/>
18.0	1.5 - 3.9	8.0	14.0	10	60	10 - 16	<input type="checkbox"/>	<input checked="" type="checkbox"/>
18.0	4.0 - 6.0	8.0	14.0	10	60	10 - 16	<input type="checkbox"/>	<input checked="" type="checkbox"/>
20.0	1.5 - 3.9	8.0	11.0	10	60	10 - 18	<input type="checkbox"/>	<input checked="" type="checkbox"/>
20.0	4.0 - 6.0	8.0	14.0	10	60	10 - 18	<input type="checkbox"/>	<input checked="" type="checkbox"/>
25.0	1.5 - 4.9	8.0	13.0	10	60	10 - 24	<input type="checkbox"/>	<input checked="" type="checkbox"/>
25.0	5.0 - 10.0	8.0	18.0	10	60	14 - 24	<input type="checkbox"/>	<input checked="" type="checkbox"/>
30.0	1.5 - 4.9	8.0	13.0	10	60	18 - 28	<input type="checkbox"/>	<input checked="" type="checkbox"/>
30.0	5.0 - 10.0	8.0	18.0	10	60	18 - 28	<input type="checkbox"/>	<input checked="" type="checkbox"/>

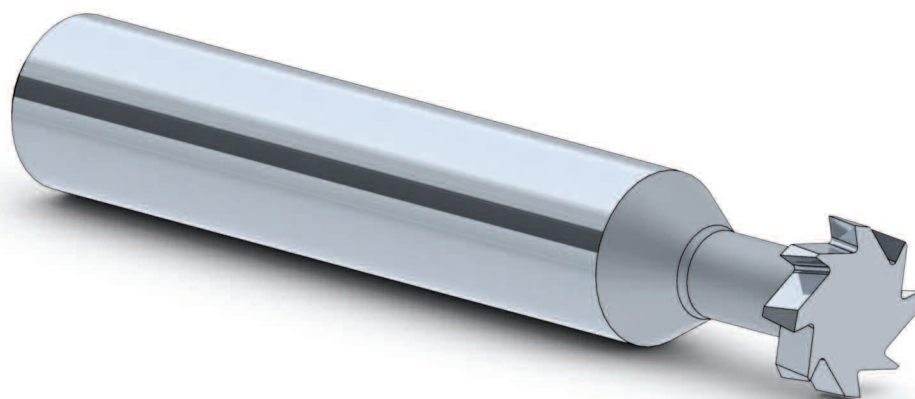

DIXI 1527

T- GLEUFFREZEN MET CONVEXE VERTANDING

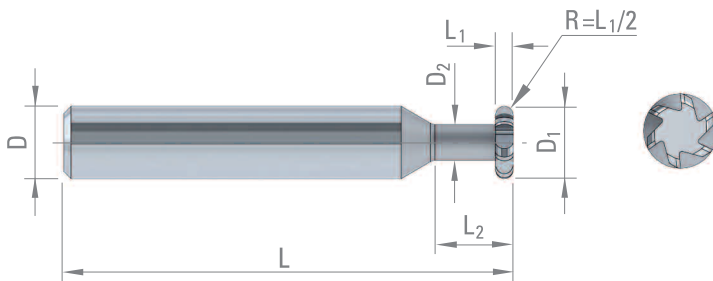

Steel + Pb	Low alloyed steel	DUPLEX stainless steel	Titanium, titanium alloy	Cu alloy Silver Gold
Al	Plastic			

D ₁ ∅ < 4.0 ±0.03 ∅ ≥ 4.0 -0.05/-0.10	L ₁	D ₂ 0/-0.20	L ₂ ±0.2	D _{h6}	L	Z	CARBIDE	CUTINOX
4.0	0.4 - 1.5	1.5	6.0	4	42	4	<input type="checkbox"/>	<input checked="" type="checkbox"/>
6.0	0.5 - 2.0	3.5	7.0	6	42	6	<input type="checkbox"/>	<input checked="" type="checkbox"/>
8.0	1.0 - 3.0	4.0	9.0	8	50	6	<input type="checkbox"/>	<input checked="" type="checkbox"/>
10.0	1.0 - 4.0	5.0	9.0	10	50	8	<input type="checkbox"/>	<input checked="" type="checkbox"/>
12.0	0.5 - 3.5	5.0	11.5	6	50	10	<input type="checkbox"/>	<input checked="" type="checkbox"/>
12.0	1.0 - 5.0	6.0	14.0	10	50	10	<input type="checkbox"/>	<input checked="" type="checkbox"/>
16.0	1.0 - 6.0	8.0	14.0	10	60	12	<input type="checkbox"/>	<input checked="" type="checkbox"/>

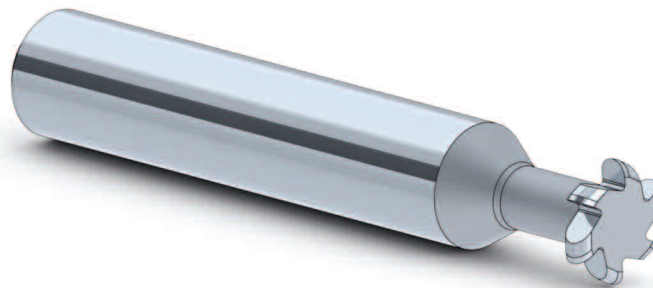

OVERIGE GEOMETRIËN EN VERTANDINGEN

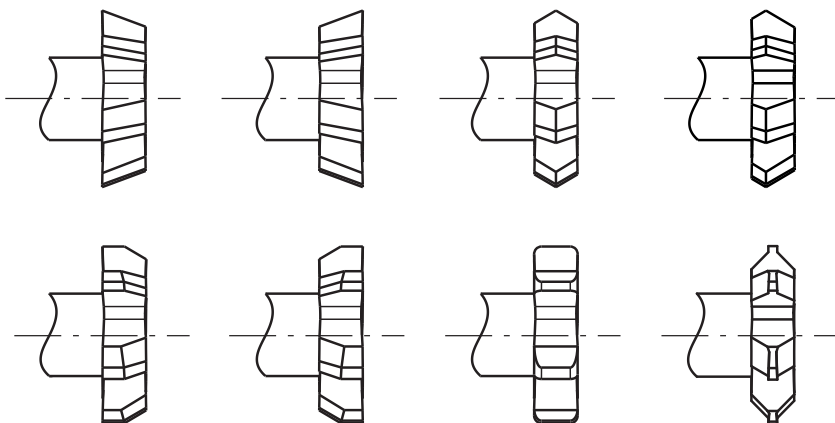

DIXI POLYTOOL B.V.

De Hofstede 11

4033 BT Lienden

T +31 (0)344 603 410

F +31 (0)344 603 488

dixiholland@dixi.com